

# **SINGER**

**251-11**

LIST OF PARTS COMPLETE  
FOR

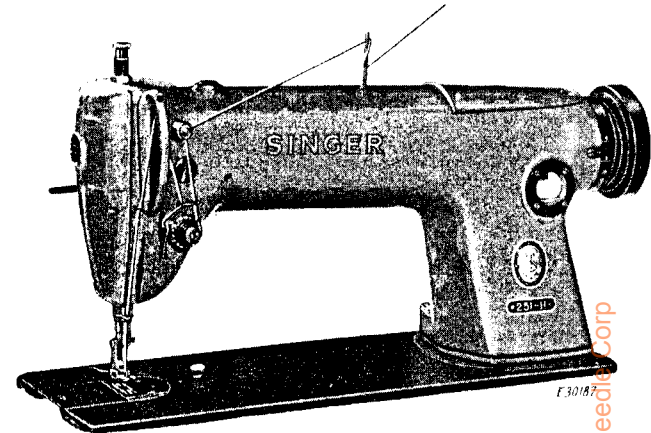

MACHINE No. 251-11

FOR GENERAL STITCHING OPERATIONS ON LIGHT TO MEDIUM WEIGHT FABRICS. HAS PENDANT LINK FEED MECHANISM. CLEARANCE UNDER PRESSER FOOT 9/32". NEEDLE BAR STROKE 1-9/64". MAXIMUM STITCH LENGTH 8 PER INCH.

No.	Plate	Name
*147001	-----	Arm .....
		NOTE: Due to the accuracy required for gear alignment, Arm cannot be supplied separately and can only be sent out as a unit, Arm and Bed assembled.
8582	8287	Arm Dowel Pin (2) .....
50608(819)	8269	Arm Hole Plug Screw (top of arm) for plugging hole used to assemble take-up oil wicks .....
140705(805)	8287	Arm Screw (back) .....
146552	8287	Arm Screw (front and intermediate) (2) ..
140315(805)	8287	Arm Screw Stud (back) (2) .....
147003	8269	Arm Shaft (horizontal) and Needle Bar Crank with 1036(830), 140542(830) and 140609(830) .....
147486	8269	Arm Shaft (horizontal) Bushing (center)
140296(830)	8269	Arm Shaft (horizontal) Bushing (center) Set Screw .....
147112	8269	Arm Shaft (horizontal) Flanged Bushing (back) .....

## PARTS FOR MACHINE No. 251-11

No.	Plate	Name
146790	8269	Arm Shaft (horizontal) Flanged Bushing (back) Oil Sump Tube .....
207(805)	8269	Arm Shaft (horizontal) Flanged Bushing (back) Oil Sump Tube Holder Screw ....
140297(830)	8269	Arm Shaft (horizontal) Flanged Bushing (back) Set Screw .....
147005	8269	Arm Shaft (horizontal) Flanged Bushing (front) .....
140279(830)	8269	Arm Shaft (horizontal) Flanged Bushing (front) Set Screw .....
144(804)	8269	Arm Shaft (horizontal) Screw (back) .....
140640(805)	8269	Arm Shaft (horizontal) Screw Plug (front)
147109	8269	Arm Shaft (horizontal) Screw Plug Washer (fiber) .....
147468	8269	Arm Shaft (horizontal) Thrust Collar with two 457(830) .....
457(830)	8269	Arm Shaft (horizontal) Thrust Collar Set Screw (2) .....
143013	8269	Arm Shaft (upright) .....
143014	8269	Arm Shaft (upright) Bevel Gear (lower) right hand spiral with two 1259(830) .....
NOTE: To ensure proper functioning of Gears, No. 143014 will not be supplied separately, but will be substituted by Pair of Gears No. 143295.		
1259(830)	8269	Arm Shaft (upright) Bevel Gear (lower) Set Screw (2) .....
143015	8269	Arm Shaft (upright) Bevel Gear (upper) Left hand spiral with two 1259(830) .....
NOTE: To ensure proper functioning of Gears, No. 143015 will not be supplied separately, but will be substituted by Pair of Gears No. 147476.		
1259(830)	8269	Arm Shaft (upright) Bevel Gear (upper) Set Screw (2) .....
143016	8269	Arm Shaft (upright) Bushing (lower) .....
140298(830)	8269	Arm Shaft (upright) Bushing (lower) Set Screw .....
147111	8269	Arm Shaft (upright) Bushing (upper) .....
50504(830)	8269	Arm Shaft (upright) Bushing (upper) Set Screw .....
147007	8272	Arm Side Shield .....
147008	8272	Arm Side Shield Wick .....
16709	8272	Arm Side Shield Wick Spring Holder .....
147010	8272	Arm Side Shield complete, Nos. 16709, 147007 and 147008 .....
217(819)	8272	Arm Side Shield Screw (2) .....
52239	8274	Arm Spool Pin and Thread Eyelet .....
8879	8274	Arm Spool Pin Washer (cloth) .....
NOTE: When ordering No. 8879, state color required.		

## PARTS FOR MACHINE No. 251-11

No.	Plate	Name
147011	8275	Arm Top Cover for 147013 .....
147012	8256	Arm Top Cover for 147014 .....
147013	8275	Arm Top Cover with Stitch Regulator Plunger complete, Nos. 64519, 146511, 147011 and 147105 .....
NOTE: No. 147013 is regularly furnished with this machine.		
147014	8256	Arm Top Cover with Stitch Regulator Plunger complete, when a longer spool pin (3-1/2 in. long) is required, Nos. 64519, 143244, 146511, 147012 and 147105 .....
147015	8275	Arm Top Cover Gasket .....
51369(813)	8275	Arm Top Cover Screw (4) .....
143244	8256	Arm Top Cover Spool with Spool Rest, 3-1/2 in. long .....
147105	8256	Arm Top Cover Stitch Regulator Plunger
140607(819)	8256	Arm Top Cover Stitch Regulator Plunger Hole Plug Screw for plugging the Plunger hole when the Plunger is removed to prevent tampering with the stitch set ....
64519	8256	Arm Top Cover Stitch Regulator Plunger Spring .....
146511	8256	Arm Top Cover Stitch Regulator Plunger Stop Ring .....
*147490	-----	Bed .....
NOTE: Due to the accuracy required for gear alignment, Bed cannot be supplied separately and can only be sent out as a unit, Arm and Bed assembled.		
143024	8287	Bed Hole Plug .....
143268	8287	Bed Leg (back) .....
1518(809)	8287	Bed Leg (back) Nut (2) .....
12431(819)	8276	Bed Slide .....
4307	8276	Bed Slide Spring .....
725(819)	8276	Bed Slide Spring Screw (2) .....
12432	8276	Bed Slide complete, Nos. 4307, 12431-(819) and two 725(819) .....
147477	8279	Bell Crank .....
147478	8279	Bell Crank Bracket .....
158(813)	8279	Bell Crank Bracket Screw (2) .....
140941(803)	8279	Bell Crank Hinge Screw .....
1650(819)	-----	Bell Crank Hinge Screw Nut .....
147479	-----	Bell Crank complete, Nos. 1650(819), 140941(803), 147477 and 147478 .....
147469	-----	Combination of Feed and Stitch Regulator Parts, Nos. 143015, 143040, 143049, 143087, 143134, 147472 and 147473 .....
147096	8280	Face Plate .....
147019	8280	Face Plate Gasket .....

From the Library of the University of Illinois at Urbana-Champaign

## PARTS FOR MACHINE No. 251-11

No.	Plate	Name
152(809)	8280	Face Plate Screw (lower) (3) .....
738(809)	8280	Face Plate Screw (upper) .....
147470	8281	Feed Bar .....
147471	-----	Feed Bar 147470 with 147290, 147355, 147356, 272110 and two 1423(803) .....
147355	8281	Feed Bar Carrier with two each 158(805) and 140788(805) .....
158(805)	8281	Feed Bar Carrier Clamping Screw (2) ....
143031	8281	Feed Bar Carrier Oil Wick .....
143032	8281	Feed Bar Carrier Oil Wick Holder .....
147024	-----	Feed Bar Carrier Oil Wick Holder 143032 with 143031 .....
228(805)	8281	Feed Bar Carrier Oil Wick Holder Screw (2) .....
272110	8281	Feed Bar Connecting Link .....
1423(803)	8281	Feed Bar Connecting Link Cap Screw (2)
147288	8281	Feed Bar Connecting Link Oil Wick .....
272111	8281	Feed Bar Connecting Link Oil Wick Clamp .....
147035	8281	Feed Bar Connecting Link Oil Wick Holder .....
50579(809)	8281	Feed Bar Connecting Link Oil Wick Holder Screw .....
147289	-----	Feed Bar Connecting Link Oil Wick Holder 147035 with 147288 .....
147356	8281	Feed Bar Hinge Pin (eccentric) .....
140788(805)	8281	Feed Bar Hinge Pin Clamping Screw (2)
147315	8276	Feed Dog, 28 teeth (22 teeth to the inch)
50117(830)	8276	Feed Dog Screw (2) .....
147472	8269	Feed Eccentric with 1375(830) and two 1036(830) .....
1375(830)	8269	Feed Eccentric Body Position Screw ....
1036(830)	8269	Feed Eccentric Body Set Screw (2).....
140568(830)	8269	Feed Eccentric Stop Screw (8 stitch) ..
NOTE: No. 140568(830) is regularly furnished with this Machine.		
140256(830)	8269	Feed Eccentric Stop Screw (7 stitch) ....
140257(830)	8269	Feed Eccentric Stop Screw (5½ stitch)
140258(830)	8269	Feed Eccentric Stop Screw (14 stitch) ..
147473	8269	Feed Lifting Eccentric and Arm Shaft ~ (horizontal) Bevel Gear, right hand spiral with 1259(830), 140333(830) and 143088 .....
NOTE: To ensure proper functioning of Gears, No. 147473 will not be supplied separately, but will be substituted by Pair of Gears No. 147476.		
140333(830)	8269	Feed Lifting Eccentric Position Screw
1259(830)	8269	Feed Lifting Eccentric Set Screw .....
147025	8281	Feed Lifting Rock Shaft .....

141151 10 stitches

## PARTS FOR MACHINE No. 251-11

No.	Plate	Name
147030	-----	Feed Lifting Rock Shaft Nos. 197(805), 140359(805), 143236, 147025, 147038, 147039, 147047 and two 147037 .....
143052	8281	Feed Lifting Rock Shaft and Feed Rock Shaft Oil Wick Holder .....
197(805)	8281	Feed Lifting Rock Shaft and Feed Rock Shaft Oil Wick Holder Screw .....
147028	8281	Feed Lifting Rock Shaft Bushing (2) ....
447(830)	8281	Feed Lifting Rock Shaft Bushing Set Screw (2) .....
143039	8281	Feed Lifting Rock Shaft Cap .....
223(805)	8281	Feed Lifting Rock Shaft Cap Screw (2)..
147029	8281	Feed Lifting Rock Shaft Collar with two 460(830) (2) .....
460(830)	8281	Feed Lifting Rock Shaft Collar Set Screw (4) .....
143040	8269	Feed Lifting Rock Shaft Connecting Rod
140230(803)	8269	Feed Lifting Rock Shaft Connecting Rod Hinge Screw .....
1518(809)	8269	Feed Lifting Rock Shaft Connecting Rod Hinge Screw Nut .....
147474	8281	Feed Lifting Rock Shaft Crank (back) with 966(805) .....
966(805)	8281	Feed Lifting Rock Shaft Crank (back) Clamping Screw .....
147290	8281	Feed Lifting Rock Shaft Crank (front) with 140915(830) .....
140915(830)	8281	Feed Lifting Rock Shaft Crank (front) Clamping Screw .....
140359(805)	8281	Feed Lifting Rock Shaft Oil Plug Screw
143236	8281	Feed Lifting Rock Shaft Oil Plug Screw Washer (fiber) .....
147038	8281	Feed Lifting Rock Shaft Oil Wick (long)
147037	8281	Feed Lifting Rock Shaft Oil Wick (short) (2) .....
147039	8281	Feed Lifting Rock Shaft Oil Wick .....
147047	8281	Feed Lifting Rock Shaft Oil Wick Clamp- ing Plate .....
197(805)	8281	Feed Lifting Rock Shaft Oil Wick Clamp- ing Plate Screw .....
147040	8281	Feed Rock Shaft .....
147041	-----	Feed Rock Shaft Nos. 197(805), 140359- (805), 143236, 147039, 147040, 147046, 147047 and two 147045.....
147042	8281	Feed Rock Shaft Bushing (back) .....
447(830)	8281	Feed Rock Shaft Bushing (back) Set Screw .....
147043	8281	Feed Rock Shaft Bushing (front).....
447(830)	8281	Feed Rock Shaft Bushing (front) Set Screw .....

## PARTS FOR MACHINE No. 251-11

No.	Plate	Name
143048	8281	Feed Rock Shaft Cap .....
223(805)	8281	Feed Rock Shaft Cap Screw (2) .....
147029	8281	Feed Rock Shaft Collar with two 460- (830) .....
460(830)	8281	Feed Rock Shaft Collar Set Screw (2)....
143049	8269	Feed Rock Shaft Connecting Rod .....
140230(803)	8269	Feed Rock Shaft Connecting Rod Hinge Screw .....
1518(809)	8269	Feed Rock Shaft Connecting Rod Hinge Screw Nut .....
147044	8281	Feed Rock Shaft Crank with 157(809)....
157(809)	8281	Feed Rock Shaft Crank Clamping Screw
140359(805)	8281	Feed Rock Shaft Oil Plug Screw .....
143236	8281	Feed Rock Shaft Oil Plug Screw Washer (fiber) .....
147046	8281	Feed Rock Shaft Oil Wick (long) .....
147045	8281	Feed Rock Shaft Oil Wick (short) (2)....
147039	8281	Feed Rock Shaft Oil Wick .....
147047	8281	Feed Rock Shaft Oil Wick Clamping Plate .....
197(805)	8281	Feed Rock Shaft Oil Wick Clamping Plate Screw .....
25878	8268	Guide (Accessories) .....
50190(819)	8268	Guide Thumb Screw (Accessories) .....
147139	8256	Machine Pulley, small rim diam., (disc power) "V" belt groove 2.9 in. with two 51283(830) .....
NOTE: No. 147139 is regularly furnished.		
51283(830)	8256	Machine Pulley Set Screw (2) .....
147140	8256	Machine Pulley large rim diam. (disc power) "V" belt groove 2.9 in. with two 51283(830) .....
147162	8282	Needle Bar (hollow) with 140239(830)....
143336	8282	Needle Bar Bushing (lower) .....
1133(830)	8282	Needle Bar Bushing (lower) Set Screw ..
52171	8282	Needle Bar Bushing (lower) Thread Eyelet .....
143324	8282	Needle Bar Bushing (upper) .....
1133(830)	8282	Needle Bar Bushing (upper) Set Screw ..
147492	8282	Needle Bar Connecting Link .....
147050	-----	Needle Bar Connecting Link 147492 with 143326 .....
140231(803)	8282	Needle Bar Connecting Link Cap Screw
143056	8282	Needle Bar Connecting Link Roller Bearing (18) .....
143326	8282	Needle Bar Connecting Stud with 140706(803) .....
140706(803)	8282	Needle Bar Connecting Stud Clamping Screw .....
147053	8272	Needle Bar Connecting Stud Oil Wick ....

## PARTS FOR MACHINE No. 251-11

No.	Plate	Name
143058	8282	Needle Bar Connecting Stud Slide Block .....
140542(830)	8269	Needle Bar Crank Position Screw .....
143196	8272	Needle Bar Oil Wick .....
140239(830)	8282	Needle Set Screw .....
146591	8231	Oil Flow Body.....
143061	8231	Oil Flow Body Gasket (2) .....
143062	8231	Oil Flow Window .....
143063	8231	Oil Flow Window Cap .....
50257(809)	8231	Oil Flow Window Cap Screw (4) .....
143370	8231	Oil Lead .....
51369(805)	8231	Oil Lead Screw .....
143064	8231	Oil Pipe for 147106 .....
143384	8231	Oil Pipe for Oiling Rotating Hook Shaft (front) Bearing .....
143065	8231	Oil Pipe Clamping Sleeve .....
143066	8231	Oil Pipe Clamping Sleeve Nut .....
147106	8231	Oil Pipe complete from Oil Pipe to Arm Shaft (horizontal) Center Bearing Nos. 143064, 143065 and 143066 .....
143387	-----	Oil Pipe 143384 with 143124 for oiling Rotating Hook Shaft Front Bearing .....
143124	8231	Oil Pipe Clamping Sleeve .....
143125	8231	Oil Pipe Clamping Sleeve Nut .....
143126	8231	Oil Pipe Clamping Sleeve Nut Adaptor ..
143070	8231	Oil Pump (centrifugal) Body with 143126 .....
143071	8231	Oil Pump (centrifugal) Body Position Pin (2) .....
157(805)	8231	Oil Pump (centrifugal) Body Screw (3) ..
143072	8231	Oil Pump (centrifugal) Cover .....
143073	8231	Oil Pump (centrifugal) Impeller .....
50123(805)	8269	Oil Pump (centrifugal) Impeller Locking Screw .....
143074	8231	Oil Pump (centrifugal) Screen .....
143075	8231	Oil Pump (centrifugal) Screen Frame ....
189(805)	8231	Oil Pump (centrifugal) Screen Frame Screw (4) .....
147107	8272	Oil Removing Wick (head end) .....
146745	8272	Oil Removing Wick (head end) Holder Body .....
147108	-----	Oil Removing Wick (head end) Holder Body 146745 with 146698 and 147107....
140553(805)	8272	Oil Removing Wick (head end) Holder Body Hinge Screw .....
146700	8272	Oil Removing Wick (head end) Holder Body Stop and Spring Clip .....
228(805)	8272	Oil Removing Wick (head end) Holder Body Stop and Spring Clip Screw .....
146698	8272	Oil Removing Wick (head end) Holder Body Spring .....

From the Library of the National Needle Corp.

## PARTS FOR MACHINE No. 251-11

No.	Plate	Name
147054	8272	Oil Removing Wick (head end) Hinge Plate and Cover .....
147055	8272	Oil Removing Wick (head end) Hinge Plate and Cover Gasket .....
1364(819)	8272	Oil Removing Wick (head end) Hinge Plate and Cover Screw (4) .....
147056	8272	Oil Removing Wick (head end) Holder Body complete, Nos. 228(805), 140553-(805), 146698, 146700, 146745, 147054, 147055 and 147107 .....
147141	8269	Oil Wick, 11 in. long, for oiling Take-up Lever, Take-up Lever Link, Needle Bar Connecting Link and Thread Take-up Lever Link Hinge Bearing (2) .....
147143	8269	Oil Wick Holder with two 147141 .....
140232(819)	8269	Oil Wick Holder Screw .....
143295	-----	Pair of Gears Nos. 143014 and 143081 .....
147476	-----	Pair of Gears Nos. 143015 and 147473 .....
147057	8285	Presser Bar (hollow) .....
147058	8285	Presser Bar Bushing (lower) .....
		NOTE: No. 143184 is used in place of No. 147058 when using Quilter or Finger Guards.
1133(830)	8285	Presser Bar Bushing (lower) Set Screw..
147392	8285	Presser Bar Guide Bracket with 50203-(830) .....
50203(830)	8285	Presser Bar Guide Bracket Clamping and Tension Releaser Screw .....
147060	8279	Presser Bar Lifter .....
69(850)	8279	Presser Bar Lifter Hinge Screw .....
147372	8285	Presser Bar Lifting Bracket .....
147027	8279	Presser Bar Lifting Lever with 448(830)
143108	8279	Presser Bar Lifting Lever Connecting Rod .....
1611(819)	8279	Presser Bar Lifting Lever Connecting Rod Nut .....
1611(819)	8279	Presser Bar Lifting Lever Connecting Rod Lock Nut .....
143191	8279	Presser Bar Lifting Lever Connecting Rod Oil Mist Retaining Disc (felt) .....
143109	8279	Presser Bar Lifting Lever Connecting Rod Swivel .....
802(819)	8279	Presser Bar Lifting Lever Hinge Screw
147373	8285	Presser Bar Lifting Lever Link .....
147062	8279	Presser Bar Lifting Lever Pin .....
448(830)	8279	Presser Bar Lifting Lever Pin Set Screw
146610	8279	Presser Bar Lifting Lever Spring .....
147291	8285	Presser Bar Spring .....
2070	8285	Presser Bar Spring Washer .....
62527	8276	Presser Foot Hinge Pin .....
147306	8276	Presser Foot Plate .....

## PARTS FOR MACHINE No. 251-11

No.	Plate	Name
147307	8276	Presser Foot Shank .....
26231	8276	Presser Foot Spring .....
147308	8276	Presser Foot (spring hinged) complete, Nos. 26231, 62527, 147306 and 147307 .....
140390(830)	8276	Presser Foot Screw .....
147091	8285	Pressure Regulating Thumb Screw and Presser Bar Guide .....
51614(809)	8285	Pressure Regulating Thumb Screw Lock Nut .....
143340	8286	Rotating Hook with 143301 and two 1253(830) .....
143341	8286	Rotating Hook 143340 with 143351, 270083 and four 1053(805) .....
143342	8286	Rotating Hook 143341 with 40274, 143346 and three 1367(805) .....
143343	-----	Rotating Hook 143341 with 40274 and three 1367(805) .....
143344	8286	Rotating Hook 143342 with 52237 .....
270010	8286	Rotating Hook Bobbin .....
52235	8286	Rotating Hook Bobbin Case .....
52236	-----	Rotating Hook Bobbin Case 52235 with 591(806), 1380(805) and 40394 .....
40392	8286	Rotating Hook Bobbin Case Latch .....
125320	8286	Rotating Hook Bobbin Case Latch Lever
2974	8286	Rotating Hook Bobbin Case Latch Lever Fulcrum Pin .....
2975	8286	Rotating Hook Bobbin Case Latch Spring
592(805)	8286	Rotating Hook Bobbin Case Latch Stop Screw .....
40393	8286	Rotating Hook Bobbin Case Latch Hinge Nos. 2974, 40392 and 125320 .....
591(806)	8286	Rotating Hook Bobbin Case Tension Regulating Screw .....
40394	8286	Rotating Hook Bobbin Case Tension Spring .....
1380(805)	8286	Rotating Hook Bobbin Case Tension Spring Screw .....
52237	8286	Rotating Hook Bobbin Case complete, Nos. 592(805), 2975, 40393 and 52236 ..
143346	8286	Rotating Hook Bobbin Case Holder .....
147475	8286	Rotating Hook Bobbin Case Holder Position Bracket .....
704(809)	8286	Rotating Hook Bobbin Case Holder Position Bracket Screw .....
140551(803)	8286	Rotating Hook Oil Flow Regulating Thumb Screw .....
143383	8286	Rotating Hook Oil Flow Regulating Thumb Screw Spring .....
233(805)	8286	Rotating Hook Oil Flow Regulating Thumb Screw Spring Screw .....

## PARTS FOR MACHINE No. 251-11

No.	Plate	Name
143301	8286	Rotating Hook Oil Wick (felt) .....
40274	8286	Rotating Hook Section .....
1367(805)	8286	Rotating Hook Section Screw (3) .....
1253(830)	8286	Rotating Hook Set Screw (2) .....
143347	8286	Rotating Hook Shaft with 143350 .....
147130	-----	Rotating Hook Shaft 143347 with 147131
143081	8286	Rotating Hook Shaft Bevel Gear (left hand Spiral) with two 1259(830) .....
NOTE: To ensure proper functioning of Gears, No. 143081 will not be supplied separately, but will be substituted by Pair of Gears No. 143295		
1259(830)	8286	Rotating Hook Shaft Bevel Gear Set Screw (2) .....
143082	8286	Rotating Hook Shaft Bushing (back) ....
140259(830)	8286	Rotating Hook Shaft Bushing (back) Set Screw .....
143382	8286	Rotating Hook Shaft Bushing (front) ....
1285(830)	8286	Rotating Hook Shaft Bushing (front) Set Screw .....
143042	8286	Rotating Hook Shaft Oil Filter Wick ....
143349	8286	Rotating Hook Shaft Oil Filter Wick Holder .....
143350	8286	Rotating Hook Shaft Oil Filter complete, Nos. 143042 and 143349 .....
147131	8286	Rotating Hook Shaft Oil Retaining Collar with two 50429(830) .....
50429(830)	8286	Rotating Hook Shaft Oil Retaining Collar Set Screw (2) .....
270083	8286	Rotating Hook Thread Guard .....
1053(805)	8286	Rotating Hook Thread Guard Screw (4)
143351	8286	Rotating Hook Wiper .....
147166	8285	Slack Thread Regulator .....
190(809)	8285	Slack Thread Regulator Screw .....
147092	8256	Stitch Length Indicator Plate .....
402(819)	8256	Stitch Length Indicator Plate Screw .....
143085	8269	Stitch Regulator .....
143134	-----	Stitch Regulator 143085 with 140549(805), 143086 and 143378 .....
143086	8269	Stitch Regulator Locking Slide .....
143087	8269	Stitch Regulator Locking Slide Ratchet Wheel .....
143088	8269	Stitch Regulator Locking Slide Ratchet Wheel Pin .....
143378	8269	Stitch Regulator Locking Slide Spring ..
140549(805)	8269	Stitch Regulator Locking Slide Spring Screw .....
2102	8274	Tension Disc (2) .....
1560(803)	8274	Tension Regulating Thumb Nut .....
1560(803)	8274	Tension Regulating Thumb Nut Lock Nut
147151	8274	Tension Releasing Disc .....

## PARTS FOR MACHINE No. 251-11

No.	Plate	Name
147159	8274	Tension Releasing Lever Body .....
147160	-----	Tension Releasing Lever (adjustable) 147159 with 50123(819) and 147161 .....
50123(819)	8274	Tension Releasing Lever (adjustable) Screw .....
147161	8274	Tension Releasing Lever Segment .....
12398	8274	Tension Releasing Lever Hinge Pin ....
12329	8274	Tension Releasing Lever Spring .....
32574	8274	Tension Releasing Pin .....
147152	8274	Tension Spring .....
140873(803)	8274	Tension Stud .....
147292	-----	Tension Stud 140873(803) with two 1560(803) .....
50305(803)	8274	Tension Stud Set Screw .....
147293	8274	Tension complete, Nos. 32574, 52083, 52394, 147151, 147152, 147292 and two 2102 .....
147090	8274	Thread Eyelet (side of arm) .....
147069	8274	Thread Guard (side of arm) .....
52454	8274	Thread Retainer .....
624(830)	8274	Thread Retainer Set Screw .....
147386	-----	Thread Take-up Crank, Thread Take-up Lever with 147079 and Thread Take-up Lever Link with 147193 and eighteen 143056 .....
147197	-----	Thread Take-up Crank, Thread Take-up Lever with 147079 and Thread Take-up Lever Link with 140231(803), 143058, 147193 and thirty-six 143056 .....
147186	8282	Thread Take-up Crank, Thread Take-up Lever with 147079, Thread Take-up Lever Link and Thread Take-up Lever Link Hinge Stud complete, Nos. 147075 and 147197 .....
140609(830)	8269	Thread Take-up Crank Clamping Screw
140610(819)	8269	Thread Take-up Crank Clamping Screw Hole Plug Screw .....
147070	8269	Thread Take-up Crank Clamping Screw Hole Plug Screw Gasket .....
1036(830)	8269	Thread Take-up Crank Set Screw .....
147193	8282	Thread Take-up Crank Wearing Plate ....
147156	8280	Thread Take-up Lever Guard .....
147077	8280	Thread Take-up Lever Guard Gasket ....
152(819)	8280	Thread Take-up Lever Guard Screw (2)..
147073	8282	Thread Take-up Lever Link Hinge Stud
147074	8282	Thread Take-up Lever Link Hinge Stud Oil Wick .....
435(830)	8282	Thread Take-up Lever Link Hinge Stud Set Screw .....
147075	-----	Thread Take-up Lever Link Hinge Stud 147073 with 147074 .....

149/28  
0017  
35B3

From the Ray and Dargatzis Needle Co.

## PARTS FOR MACHINE No. 251-11

No.	Plate	Name
147078	8272	Thread Take-up Lever Oil Guard with 143196 and 147053 .....
217(805)	8272	Thread Take-up Lever Oil Guard Screw
143056	8282	Thread Take-up Lever Roller Bearing (18)
147079	8282	Thread Take-up Lever Thread Eyelet Bushing .....
52394	8274	Thread Take-up Spring .....
52083	8274	Thread Take-up Spring Regulator with 50305(803) .....
448(830)	8274	Thread Take-up Spring Regulator Set Screw .....
147320(850)	8276	Throat Plate (small needle hole) for 147315, No. 54 Drill, No. 5 Needle Position, No. 14 or No. 16 Needle .....
		NOTE: Throat Plate No. 147320(850) is sent with this Machine unless otherwise specified.
691(850)	8276	Throat Plate Screw (2) .....

## MACHINE NO. 251-12

FOR GENERAL STITCHING OPERATIONS ON LIGHT TO MEDIUM HEAVY WEIGHT FABRICS. HAS PENDANT LINK FEED MECHANISM. CLEARANCE UNDER PRESSER FOOT 5/16". NEEDLE BAR STROKE 1-13/64". MAXIMUM STITCH LENGTH 8 PER INCH.

This Machine is the same as the 251-11 Machine with the following exceptions:

No.	Plate	Name
147081	8270	Arm Shaft (horizontal) and Needle Bar Crank with 1036(830), 140542(830) and 140609(830), in place of 147003 .....
147085	8273	Arm Side Shield, in place of 147007 .....
147086	8273	Arm Side Shield complete, Nos. 16709, 147008 and 147085, in place of 147010 .....
147163	8283	Needle Bar (hollow) in place of 147162 .....
147164	-----	Needle Bar 147163 with 143386, for size 16 x 257 Needle .....
147113	8283	Needle Bar Bushing (lower) in place of 143336 .....
147114	8283	Needle Bar Bushing (lower) Thread Eyelet, in place of 52171 .....
143327	8283	Needle Bar Thread Guard for 143386 .....
665(809)	8283	Needle Bar Thread Guard Screw for 143386 .....
143386	-----	Needle Clamp 143328 with 665(809) and 143327 .....
143328	8283	Needle Clamp with 140119(830) for 143386 .....
140119(830)	8283	Needle Clamp Screw for 143328 .....
147144	8270	Oil Wick Holder with two 147141, in place of 147143 .....
147346(850)	8277	Throat Plate (small needle hole) for 147315, No. 54 Drill, No. 14 or No. 16 Needle, No. 2 Needle Position in place of 147320(850) .....



## MACHINE NO. 251-13

FOR GENERAL STITCHING OPERATIONS ON LIGHT TO HEAVY WEIGHT FABRICS (3/8" PRESSER BAR LIFT) AND EXTRA HEAVY WEIGHT FABRICS (7/16" PRESSER BAR LIFT). HAS PENDANT LINK FEED MECHANISM. CLEARANCE UNDER PRESSER FOOT 3/8". NEEDLE BAR STROKE 1-7/16". MAXIMUM STITCH LENGTH 5-1/2 PER INCH.

This Machine is the same as the 251-11 Machine with the following exceptions:

No.	Plate	Name
147081	8271	Arm Shaft (horizontal) and Needle Bar Crank with 1036(830), 140542(830) and 140609(830), in place of 147003 .....
147085	8273	Arm Side Shield, in place of 147007 .....
147086	8273	Arm Side Shield complete, Nos. 16709, 147008 and 147085, in place of 147010 .....
149174	8278	Feed Dog, 17 teeth (14 teeth to the inch) for 143175(850), in place of 147315 .....
140257(830)	8271	Feed Eccentric Stop Screw (5½ stitch) in place of 140568(830) .....
147163	8284	Needle Bar (hollow) in place of 147162 .....
147164	-----	Needle Bar 147163 with 143386, for size 16 x 257 and 16 x 261 Needles .....
147113	8284	Needle Bar Bushing (lower) in place of 143336 .....
147114	8284	Needle Bar Bushing (lower) Thread Eyelet, in place of 52171 .....
143327	8284	Needle Bar Thread Guard for 143386 .....
665(809)	8284	Needle Bar Thread Guard Screw for 143386 .....
143386	-----	Needle Clamp 143328 with 665(809) and 143327 .....
143328	8284	Needle Clamp with 140119(830) for 143386 .....
140119(830)	8284	Needle Clamp Screw for 143328 .....
147145	8271	Oil Wick Holder with two 147141, in place of 147143 .....
62527	8278	Presser Foot Hinge Pin for 127234 .....
127233	8278	Presser Foot Plate for 127234 .....
52390	8278	Presser Foot Shank for 127234 .....
26231	8278	Presser Foot Spring for 127234 .....
127234	8278	Presser Foot (spring hinged) complete, Nos. 26231, 52390, 62527 and 127233, in place of 147308 .....
147387	-----	Thread Take-up Crank, Thread Take-up Lever with 147079 and Thread Take-up Lever Link with 147193 and eighteen 143056, in place of 147386 .....

No.	Plate	Name
147198	-----	Thread Take-up Crank, Thread Take-up Lever with 147079 and Thread Take-up Lever Link with 140231(803), 143058, 147193 and thirty-six 143056, in place of 147197 .....
147187	-----	Thread Take-up Crank, Thread Take-up Lever with 147079, Thread Take-up Lever Link and Thread Take-up Lever Link Hinge Stud complete, Nos. 147075 and 147198, in place of 147186 .....
143175(850)	8278	Throat Plate (large needle hole) for 149174, in place of 147320(850) .....

**FITTINGS**  
**For Attaching Cuff**  
**(Setting Cuff)**  
**For No. 251-11 Machine**

No.	Plate	Name
149031	8288	Feed Dog, 19 teeth (22 teeth to the inch) .....
18055	8288	Presser Foot Hinge Pin .....
143216	8288	Presser Foot Plate.....
143217	8288	Presser Foot Shank .....
143318	8288	Presser Foot Yielding Plate .....
143320	8288	Presser Foot Yielding Plate Spring.....
143219	8288	Presser Foot (hinged) long toes, with right hand Yielding Plate complete, Nos. 18055, 143216, 143217, 143318 and 143320 .....
147336(850)	8288	Throat Plate (small needle hole) No. 54 Drill, No. 5 Needle Position, No. 14 or No. 16 Needle .....
147337	8288	Throat Plate Cuff Guide .....
665(809)	8288	Throat Plate Cuff Guide Screw .....
147338	8288	Throat Plate with Cuff Guide complete, Nos. 665(809), 147336 and 147337 .....

**For Banding**  
**(Setting Collar Band)**  
**For No. 251-11 Machine**

No.	Plate	Name
147305	8289	Feed Dog, 28 teeth (22 teeth to the inch) .....
62527	8289	Presser Foot Hinge Pin .....
147325	8289	Presser Foot Plate .....
62926	8289	Presser Foot Shank .....
26231	8289	Presser Foot Spring .....
147326	8289	Presser Foot (spring hinged) complete, for 3/16 in., 7/32 in., and 1/4 in. margin, Nos. 26231, 62527, 62926 and 147325 ..

NOTE: When ordering No. 147326, state margin required.

147309(850)	8289	Throat Plate (small needle hole) No. 54 Drill, No. 5 Needle Position, No. 14 or No. 16 Needle .....
-------------	------	---

**For Basting**  
**For No. 251-11 Machine**

No.	Plate	Name
147305	8289	Feed Dog, 28 teeth (22 teeth to the inch) .....
62527	8289	Presser Foot Hinge Pin .....
147306	8289	Presser Foot Plate.....
147307	8289	Presser Foot Shank .....
26231	8289	Presser Foot Spring .....
147308	8289	Presser Foot (spring hinged) complete, Nos. 26231, 62527, 147306 and 147307 .....
147309(850)	8289	Throat Plate (small needle hole) No. 54 Drill, No. 5 Needle Position, No. 14 or No. 16 Needle .....

**For Beading or Center Stitching**  
**For No. 251-11 Machine**

No.	Plate	Name
160675	8290	Edge Guide .....
1443(809)	8290	Edge Guide Screw (2) .....
160676	8290	Edge Guide Shank .....
160677	8290	Edge Guide on Shank complete, Nos. 160675, 160676 and two 1443(809) .....
147327	8290	Feed Dog, 23 teeth (22 teeth to the inch) .....
160671	8290	Presser Foot Compensating Plate (left) .....
160672	8290	Presser Foot Compensating Plate (right) .....
1264(809)	8290	Presser Foot Hinge Screw (2).....
160673	8290	Presser Foot Shank .....
193252	8290	Presser Foot Spring (2) .....
160674	8290	Presser Foot (compensating, double) complete, Nos. 160671, 160672, 160673 and two each 1264(809) and 193252 .....
147328(850)	8290	Throat Plate (large needle hole) No. 46 Drill, No. 5 Needle Position, from No. 16 to No. 22 Needle .....

Library of: Diamond Needle Corp.

**For Cuff Running  
(Edgestitching Cuff)  
For No. 251-11 Machine**

No.	Plate	Name
147305	8291	Feed Dog, 28 teeth (22 teeth to the inch)
62527	8291	Presser Foot Hinge Pin .....
147329	8291	Presser Foot Plate .....
702(830)	8291	Presser Foot Plate Adjusting Screw .....
1772(809)	8291	Presser Foot Plate Adjusting Screw Nut ..
147330	8291	Presser Foot Shank with 702(830) and 1772(809) .....
26231	8291	Presser Foot Spring .....
147331	8291	Presser Foot (spring hinged) complete, for 1/16 in. margin, Nos. 26231, 62527, 147329 and 147330 .....
147309(850)	8291	Throat Plate (small needle hole) No. 54 Drill, No. 5 Needle Position, No. 14 or No. 16 Needle .....

**For Hem Collar Band  
For No. 251-11 Machine**

No.	Plate	Name
147321	8291	Feed Dog, 15 teeth (22 teeth to the inch)
62527	8291	Presser Foot Hinge Pin .....
147322	8291	Presser Foot Plate .....
62926	8291	Presser Foot Shank .....
26231	8291	Presser Foot Spring .....
147323	8291	Presser Foot (spring hinged) complete, Nos. 26231, 62527, 62926 and 147322 .....
147324(850)	8291	Throat Plate (small needle hole) No. 54 Drill, No. 5 Needle Position, No. 14 or No. 16 Needle .....

**For Interband Lining  
For No. 251-11 Machine**

No.	Plate	Name
147315	8292	Feed Dog, 28 teeth (22 teeth to the inch)
140896(830)	8292	Presser Foot Hinge Screw .....
147316	8292	Presser Foot Plate .....
147317	8292	Presser Foot Shank .....
143320	8292	Presser Foot Yielding Plate Spring .....
147318	8292	Presser Foot Yielding Plate .....
147319	8292	Presser Foot (hinged) with right hand Yielding Plate complete, for 1/16 in. step, for 3/32 in. stitch margin and 3/8 in. mar- gin from center of needle to right hand side, Nos. 140896(830), 143320, 147316, 147317 and 147318 .....
147320(850)	8292	Throat Plate (small needle hole) No. 54 Drill, No. 5 Needle Position, No. 14 or No. 16 Needle .....

**For Pants Seaming  
For No. 251-12 Machine**

No.	Plate	Name
147315	8298	Feed Dog, 28 teeth (22 teeth to the inch)
62527	8298	Presser Foot Hinge Pin .....
147306	8298	Presser Foot Plate .....
147307	8298	Presser Foot Shank .....
26231	8298	Presser Foot Spring .....
147308	8298	Presser Foot (spring hinged) complete, Nos. 26231, 62527, 147306 and 147307.....
147388(850)	8298	Throat Plate (small needle hole) No. 52 Drill, No. 2 Needle Position, No. 19 Needle .....

For Pocket Setting  
For No. 251-11 Machine

No.	Plate	Name
147315	8293	Feed Dog, 28 teeth (22 teeth to the inch) .....
140896(830)	8293	Presser Foot Hinge Screw .....
147332	8293	Presser Foot Plate .....
147333	8293	Presser Foot Shank .....
26231	8293	Presser Foot Spring .....
147334	8293	Presser Foot Yielding Plate .....
147335	8293	Presser Foot (hinged) with right hand Yielding Plate complete, for 1/16 in. step and 1/32 in. stitch margin, Nos. 26231, 140896(830), 147332, 147333 and 147334 .....
140896(830)	8293	Presser Foot Hinge Screw .....
147378	8293	Presser Foot Plate .....
147333	8293	Presser Foot Shank .....
26231	8293	Presser Foot Spring .....
147379	8293	Presser Foot Yielding Plate .....
147380	8293	Presser Foot (hinged) with right hand Yielding Plate complete, for 1/16 in. step and 1/16 in. stitch margin, Nos. 26231, 140896(830), 147333, 147378 and 147379 .....
140908(830)	8293	Presser Foot Hinge Screw .....
147381	8293	Presser Foot Plate .....
147382	8293	Presser Foot Shank .....
26231	8293	Presser Foot Spring .....
147379	8293	Presser Foot Yielding Plate .....
147383	8293	Presser Foot (hinged) with right hand Yielding Plate complete, for 1/16 in. step and 1/4 in. stitch margin, Nos. 26231, 140908(830), 147379, 147381 and 147382 .....
147320(850)	8293	Throat Plate (small needle hole) No. 54 Drill, No. 5 Needle Position, No. 14 or No. 16 Needle .....

For Pocket Setting  
For No. 251-12 Machine

No.	Plate	Name
147315	8299	Feed Dog, 28 teeth (22 teeth to the inch) .....
140896(830)	8299	Presser Foot Hinge Screw .....
147332	8299	Presser Foot Plate .....
147333	8299	Presser Foot Shank .....
26231	8299	Presser Foot Spring .....
147334	8299	Presser Foot Yielding Plate .....
147335	8299	Presser Foot (hinged) with right hand Yielding Plate complete, for 1/16 in. step and 1/32 in. stitch margin, Nos. 26231, 140896(830), 147332, 147333 and 147334 .....
140896(830)	8299	Presser Foot Hinge Screw .....
147378	8299	Presser Foot Plate .....
147333	8299	Presser Foot Shank .....
26231	8299	Presser Foot Spring .....
147379	8299	Presser Foot Yielding Plate .....
147380	8299	Presser Foot (hinged) with right hand Yielding Plate complete, for 1/16 in. step and 1/16 in. stitch margin, Nos. 26231, 140896(830), 147333, 147378 and 147379 .....
140908(830)	8299	Presser Foot Hinge Screw .....
147381	8299	Presser Foot Plate .....
147382	8299	Presser Foot Shank .....
26231	8299	Presser Foot Spring .....
147379	8299	Presser Foot Yielding Plate .....
147383	8299	Presser Foot (hinged) with right hand Yielding Plate complete, for 1/16 in. step and 1/4 in. stitch margin, Nos. 26231, 140908(830), 147379, 147381 and 147382 .....
147346(850)	8299	Throat Plate (small needle hole) No. 54 Drill, No. 2 Needle Position, No. 14 or No. 16 Needle .....

From the Abaco Sewing Machine Needle Catalog

## For Running Collars

## For No. 251-11 Machine

No.	Plate	Name
147305	8294	Feed Dog, 28 teeth (22 teeth to the inch)
62527	8294	Presser Foot Hinge Pin .....
147310	8294	Presser Foot Plate .....
147307	8294	Presser Foot Shank .....
26231	8294	Presser Foot Spring .....
147312	8294	Presser Foot (spring hinged) complete, for 3/16 in. margin, Nos. 26231, 62527, 147307 and 147310 .....
147309(850)	8294	Throat Plate (small needle hole) No. 54 Drill, No. 5 Needle Position, No. 14 or No. 16 Needle .....

## For Running Collars

## For No. 251-12 Machine

No.	Plate	Name
147305	8298	Feed Dog, 28 teeth (22 teeth to the inch)
62527	8298	Presser Foot Hinge Pin .....
147306	8298	Presser Foot Plate .....
147307	8298	Presser Foot Shank .....
26231	8298	Presser Foot Spring .....
147308	8298	Presser Foot (spring hinged) complete, Nos. 26231, 62527, 147306 and 147307
147374(850)	8298	Throat Plate (small needle hole) No. 54 Drill, No. 2 Needle Position, No. 14 or No. 16 Needle .....

## For Sleeve Binding

## For No. 251-11 Machine

No.	Plate	Name
149603	8295	Feed Dog, 20 teeth (16 teeth to the inch)
26606	8295	Throat Plate .....
151435	-----	Puller Feed Device complete, Nos. 147344, 150733 and 151434 .....

NOTE: For component parts of Puller Feed Device complete No. 151435, see Page No. 30

## For Sleeve Plackets

## For No. 251-11 Machine

No.	Plate	Name
147315	8294	Feed Dog, 28 teeth (22 teeth to the inch)
147369	8294	Presser Foot Compensating Plate (left)
147370	8294	Presser Foot Compensating Plate (right)
160673	8294	Presser Foot Shank .....
140904(830)	8294	Presser Foot Shank Hinge Screw (2) .....
193252	8294	Presser Foot Spring (2) .....
147371	8294	Presser Foot (spring hinged) complete, Nos. 147369, 147370, 160673 and two each 140904(830) and 193252 .....
147320(850)	8294	Throat Plate (small needle hole) No. 54 Drill, No. 5 Needle Position, No. 14 or No. 16 Needle .....

## For Sleeve Plackets

## For No. 251-12 Machine

No.	Plate	Name
147315	21251	Feed Dog, 28 teeth (22 teeth to the inch)
147369	21251	Presser Foot Compensating Plate (left)
147370	21251	Presser Foot Compensating Plate (right)
160673	21251	Presser Foot Shank .....
140904(830)	21251	Presser Foot Shank Hinge Screw (2) .....
193252	21251	Presser Foot Spring (2) .....
147371	21251	Presser Foot (spring hinged) complete, Nos. 147369, 147370, 160673 and two each 140904(830) and 193252 .....
147346(850)	21251	Throat Plate (small needle hole) No. 54 Drill, No. 2 Needle Position, No. 14 or No. 16 Needle .....

From the library of: Diamond Needle Corp.

## For First Shoulder Joining

## For No. 251-11 Machine

No.	Plate	Name
149057	8296	Feed Dog, 21 teeth (22 teeth to the inch)
62527	8296	Presser Foot Hinge Pin .....
147339	8296	Presser Foot Plate .....
62926	8296	Presser Foot Shank .....
26231	8296	Presser Foot Spring .....
147340	8296	Presser Foot (spring hinged) complete, for 1/4 in. margin, Nos. 26231, 62527, 62926 and 147339 .....
142060(850)	8296	Throat Plate (small needle hole) No. 53 Drill, No. 5 Needle Position, No. 18 Needle .....

For Second Shoulder Joining  
and Stitching Down Collar

## For No. 251-11 Machine

No.	Plate	Name
149057	8296	Feed Dog, 21 teeth (22 teeth to the inch)
18055	8296	Presser Foot Hinge Pin .....
143216	8296	Presser Foot Plate .....
143217	8296	Presser Foot Shank .....
143318	8296	Presser Foot Yielding Plate .....
143320	8296	Presser Foot Yielding Plate Spring.....
143219	8296	Presser Foot (hinged) long toes with right hand Yielding Plate complete, Nos. 18055, 143216, 143217, 143318 and 143320 .....
142060(850)	8296	Throat Plate (small needle hole) No. 53 Drill, No. 5 Needle Position, No. 18 Needle .....

For Top Stitch Collars  
(Edgestitching)

## For No. 251-11 Machine

No.	Plate	Name
149137	8297	Feed Dog, 1/8 in. stitch (22 teeth to the inch) 8 teeth front and 5 teeth back of needle .....
62527	8297	Presser Foot Hinge Pin .....
147313	8297	Presser Foot Plate .....
62926	8297	Presser Foot Shank .....
26231	8297	Presser Foot Spring .....
147314	8297	Presser Foot (spring hinged) complete, for 3/32 in. margin, Nos. 26231, 62527, 62926 and 147313 .....
143278(850)	8297	Throat Plate (small needle hole).....

For Top Stitching Slash Pockets  
on Ivy League Pants

## For No. 251-11 Machine

No.	Plate	Name
147315	8297	Feed Dog, 28 teeth (22 teeth to the inch)
26276	8297	Presser Foot Hinge Pin .....
147347	8297	Presser Foot Plate .....
702(830)	8297	Presser Foot Plate Adjusting Screw.....
1772(809)	8297	Presser Foot Plate Adjusting Screw Nut
147348	8297	Presser Foot Shank with 702(830) and 1772(809) .....
26231	8297	Presser Foot Spring .....
147349	8297	Presser Foot (spring hinged) complete, Nos. 26231, 26276, 147347 and 147348
147320(850)	8297	Throat Plate (small needle hole) No. 54 Drill, No. 5 Needle Position, No. 14 or No. 16 Needle .....

from the library of: Diamond Needle Co.

For Top Stitching Slash Pockets  
on Ivy League Pants

For No. 251-12 Machine

No.	Plate	Name
147315	21251	Feed Dog, 28 teeth (22 teeth to the inch)
26276	21251	Presser Foot Hinge Pin .....
147347	21251	Presser Foot Plate .....
702(830)	21251	Presser Foot Plate Adjusting Screw ....
1772(809)	21251	Presser Foot Plate Adjusting Screw Nut
147348	21251	Presser Foot Shank with 702(830) and 1772(809) .....
26231	21251	Presser Foot Spring .....
147349	21251	Presser Foot (spring hinged) complete, Nos. 26231, 26276, 147347 and 147348
147346(850)	21251	Throat Plate (small needle hole) No. 54 Drill, No. 2 Needle Position, No. 14 or No. 16 Needle .....

PULLER FEED DEVICE COMPLETE No. 151435

No.	Plate	Name
146973	21253	Driving Pulley (auxiliary) .....
647(819)	21253	Driving Pulley (auxiliary) Set Screw (3)
147343	21253	Machine Pulley, small rim diameter (disc power) "V" belt groove (outside diameter of belt groove 2.9 in.) with two 51283(830) .....
147344	-----	Machine Pulley with Driving Pulley (auxiliary) complete, Nos. 146973, 147343 and three 647(819) .....
51283(830)	21253	Machine Pulley Set Screw (2) .....
151424	21252	Puller Feed Base with 200364(803), 259061 end two each 200902(804) and 205796 .....
259074	21252	Pulley Feed Base Block .....
200710	21252	Puller Feed Base Bolt (2) .....
9842	21252	Puller Feed Base Bolt Washer (2) .....
150733	21253	Puller Feed Driving Belt 33 in. outside length for "V" Drive .....
259056	21252	Puller Feed Driving Gear with 200394- (803) .....
270229	21252	Puller Feed Driving Gear and Pinion ..
1463(806)	-----	Puller Feed Driving Gear and Pinion Screw .....

Puller Feed Device complete No. 151435

(Continued)

No.	Plate	Name
200394(803)	21252	Pulley Feed Driving Gear Set Screw .....
259057	21252	Puller Feed Driving Pinion .....
259468	21252	Puller Feed Driving Pulley with 200373(803) .....
1463(806)	-----	Puller Feed Driving Pulley Screw .....
200373(803)	-----	Puller Feed Driving Pulley Set Screw....
151425	21252	Puller Feed Idler Gear .....
151426	21252	Puller Feed Idler Gear Bracket and Driving Pulley Shaft .....
151427	21252	Puller Feed Idler Gear Bracket and Driving Pulley Shaft Collar .....
155(805)	-----	Puller Feed Idler Gear Bracket and Driving Pulley Shaft Screw .....
200364(803)	21252	Puller Feed Idler Gear Bracket and Driving Pulley Shaft Set Screw .....
140897(803)	21252	Puller Feed Idler Gear Hinge Screw .....
151428	21252	Puller Feed Roll (lower, 3-1/2 in. long) with 453(830) .....
453(830)	21252	Puller Feed Roll (lower) Set Screw .....
151429	21252	Puller Feed Roll (lower) Shaft .....
151430	21252	Puller Feed Roll (lower) Shaft 151429 with 151428 .....
151431	21252	Puller Feed Roll (upper) with 453(830) ..
453(830)	21252	Puller Feed Roll (upper) Set Screw .....
151432	21252	Puller Feed Roll (upper) Shaft .....
151433	-----	Puller Feed Roll (upper) Shaft 151432 with 151431 .....
*259061	-----	Puller Feed Roll (upper) Shaft Bearing
200902(804)	21252	Puller Feed Roll (upper) Shaft Bearing Screw (2) .....
205796	21252	Puller Feed Roll (upper) Shaft Bearing Spring (2) .....
270233	-----	Puller Feed Roll (upper) Shaft Collar....
259063	21252	Puller Feed Roll Shaft Gear with 200394(803) (2) .....
200394(803)	21252	Puller Feed Roll Shaft Gear Set Screw (2)
151434	21252	Puller Feed Device Nos. 155(805), 140897(803), 151424, 151425, 151426, 151427, 151430, 151433, 259056, 259057, 259074, 259468, 270229, 270233 and two 1463(806), 9842, 200710 and 259063 .....
151435	-----	Puller Feed Device complete, for sleeve binding, Nos. 147344, 150733 and 151434

## ACCESSORIES

No.	Plate	Name
270010	8286	Bobbin (2) .....
143308	8268	Machine Base and Oil Reservoir Cushion (4) .....
12361	8268	Machine Hinge Connection (2) .....
41400	8268	Machine Rest Pin (wood) .....
121741	8268	One Quart Can filled with light grade stainless oil .....
228476	8268	Screw Driver .....
120440	8268	Screw Driver .....
259477	8268	Screw Driver 5 in. long .....
146057	8268	Wrench (socket) for 140609(830) .....
		NOTE: No. 146057 is not regularly furnished.
8908	8268	Wrench .....
		NOTE: No. 8908 is not regularly furnished.
11140	8268	Wrench .....
		NOTE: No. 11140 is not regularly furnished.

## BOBBIN WINDER NO. 259462

(Swinging Automatic, Right Hand)

for "V" Belt Drive

No.	Plate	Name
259428	23253	Brake (leather) .....
259429	23253	Brake Clamp .....
200113(806)	23253	Brake Clamp Screw .....
225453	23253	Frame with 202277 and 259660 .....
225454	23253	Frame Hinge Pin .....
202277	23253	Frame Oil Packing (wick) .....
259660	23253	Frame Oil Well Washer .....
225455	23253	Frame Spring .....
225456	23253	Frame Spring Plunger .....
259461	23253	Pulley with 200380(803) .....
200380(803)	23253	Pulley Set Screw .....
225381	23253	Spindle .....
225444	23253	Stop Latch .....
200056(805)	23253	Stop Latch Screw .....
225458	23253	Stop Latch Thumb Lever .....
225459	23253	Stop Latch Thumb Lever Hinge Stud .....
225459	23253	Stop Latch Thumb Lever Joint Stud .....
202478	23253	Stop Latch Trip Lever .....
200299(819)	23253	Stop Latch Trip Lever Hinge Screw .....

## BOBBIN WINDER NO. 259462

(Swinging Automatic, Right Hand)

For "V" Belt Drive

(Continued)

No.	Plate	Name
225461	23253	Tension Bracket with 201499(819).....
200082(804)	23253	Tension Bracket Screw .....
228026	23253	Tension Bracket Screw Washer .....
2102	23253	Tension Disc (2) .....
13710	23253	Tension Spring .....
201499(819)	23253	Tension Stud .....
201572(819)	23253	Tension Stud Thumb Nut .....
225462	23253	Bobbin Winder Tension Bracket complete Nos. 13710, 201572(819), 225461 and two 2102 .....
259662	23253	Bobbin Winder and Tension Bracket Base
259462	23253	Bobbin Winder complete, for "V" belt, Nos. 200056(805), 200082(804), 200113(806), 200299(819), 202478, 225381, 225444, 225453, 225454, 225455, 225456, 225458, 225462, 228026, 259428, 259429, 259461, 259662, two each 225459 and wood screws 3/4 in. No. 12 R.H.B.

## KNEE LIFTER PARTS

No.	Plate	Name
147480	21255	Bell Crank Plunger .....
143280	21254	Rock Shaft .....
147481	-----	Rock Shaft 143280 with 147482, 147483 and 147485 .....
147482	21254	Rock Shaft Crank with 140351(830) and 143282 .....
140350(830)	21254	Rock Shaft Crank Adjusting Screw .....
143282	-----	Rock Shaft Crank Adjusting Screw 140350(803) with 51649(809) .....
51649(809)	21254	Rock Shaft Crank Adjusting Screw Lock Nut .....
140351(830)	21254	Rock Shaft Crank Clamping Screw .....
147487	21254	Rock Shaft Knee Arm .....
147489	21254	Rock Shaft Knee Arm Hub with 140351(830) and 140737(803) .....



## KNEE LIFTER PARTS

(Continued)

No.	Plate	Name
140351(830)	21254	Rock Shaft Knee Arm Hub Clamping Screw .....
140737(803)	21254	Rock Shaft Knee Arm Set Screw .....
147488	-----	Rock Shaft Knee Arm complete, Nos. 2767, 147487 and 147489 .....
2767	21254	Rock Shaft Knee Arm Plate with 356(803)
356(803)	21254	Rock Shaft Knee Arm Plate Set Screw ..
147485	21254	Rock Shaft Spring .....
147483	21254	Rock Shaft Stop Dog with 140351(830) ..
140351(830)	21254	Rock Shaft Stop Dog Clamping Screw ..
147484	21254	Rock Shaft complete, Nos. 147481 and 147488.....

## MACHINE BASE AND OIL RESERVOIR

No.	Plate	Name
147491	21255	Machine Base and Oil Reservoir .....
143257	21255	Machine Base and Oil Reservoir Gasket (cork) .....
50741(805)	21255	Machine and Machine Base and Oil Reservoir Screw (for shipping purposes only) .....
140343(805)	21255	Machine and Machine Base and Oil Reservoir Screw Hole Plug Screw .....
143359	21255	Machine Base and Oil Reservoir Screw Retainer (for shipping purposes only) ....
143360	21255	Machine Base and Oil Reservoir Screw Cotter Pin (for shipping purposes only)

## THREAD UNWINDER

For Two Spools or Two Large Cones of Thread

No.	Plate	Name
228764	24193	Spool Pin (2) .....
228766	24193	Spool Rest with 201254(803) .....
150203	24193	Spool Rest Cushion (felt) (2) .....
228767	24193	Spool Rest Rod .....
201254(803)	24193	Spool Rest Set Screw .....
228768	24193	Spool Stand .....

## THREAD UNWINDER

For Two Spools or Two Large Cones of Thread

(Continued)

No.	Plate	Name
228769	24193	Thread Guide (2) .....
228770	24193	Thread Guide Holder .....
228774	24193	Thread Guide Rod .....
228776	24193	Thread Unwinder complete, for two spools Nos. 228766, 228767, 228768, 228770, 228774, two each 150203, 228764, 228769 and three wood screws 7/8 in. No. 12 .....
27739	-----	Thread Cone (wood) for large cones .....
225390	-----	Thread Cone Holder, for inverted cones

NOTE: No. 27739 and 225390 are used with, but not included in 228776

8231-1/2

147106

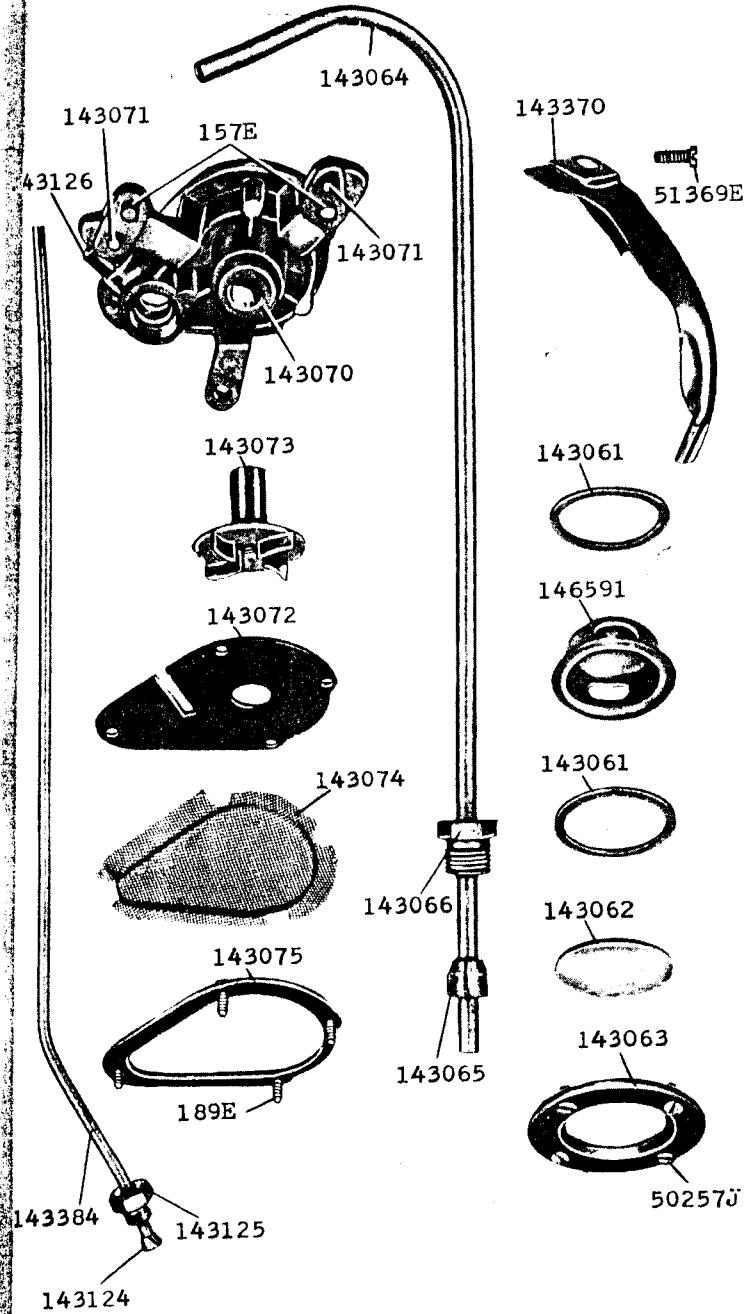

8256-1/2

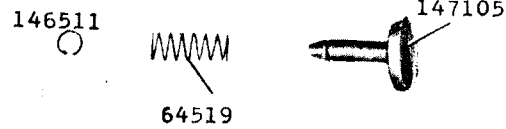
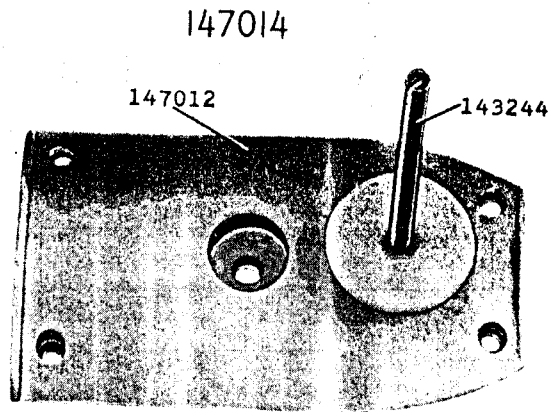
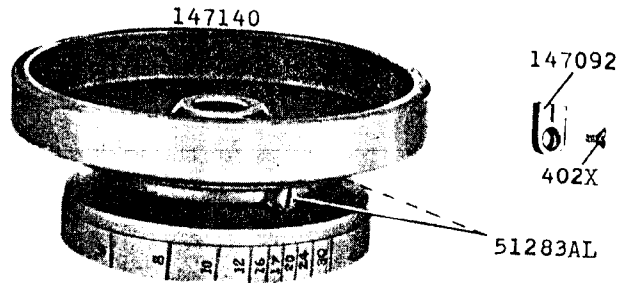
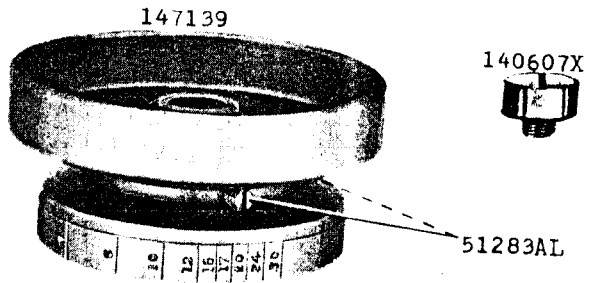

8268-1/2

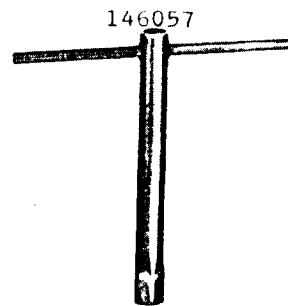
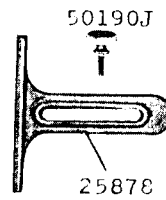
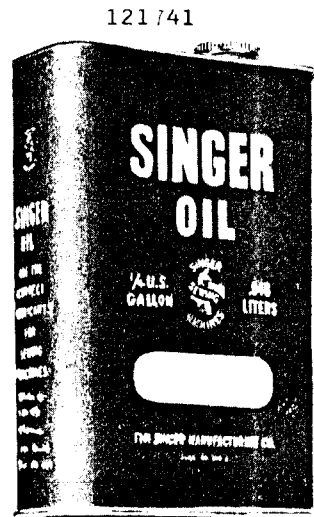

From the library of: Diamond Needle Corp.

8269-1/3

25I-II

8270-1/3

25I-I2

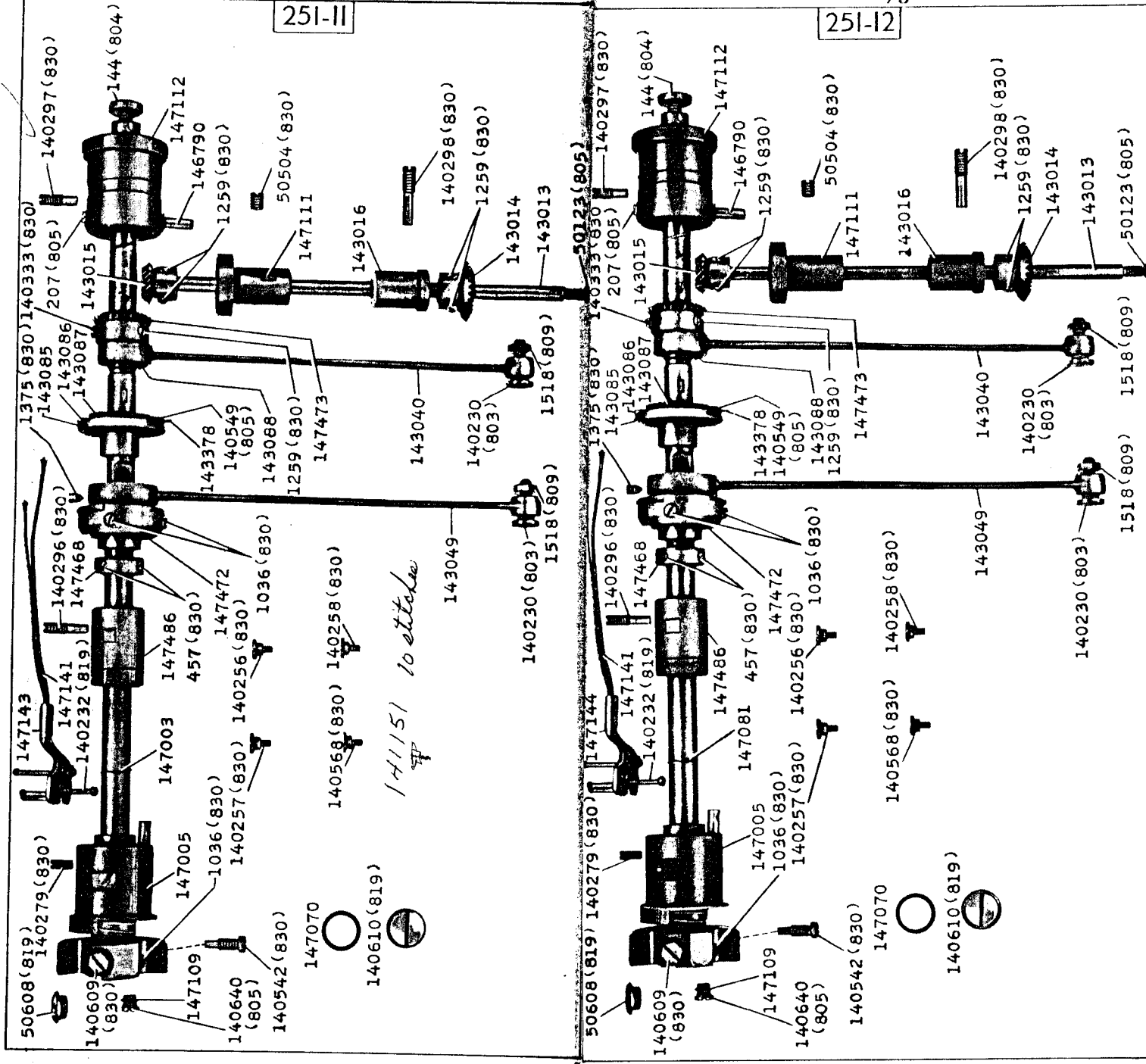

8271-1/3

251-13

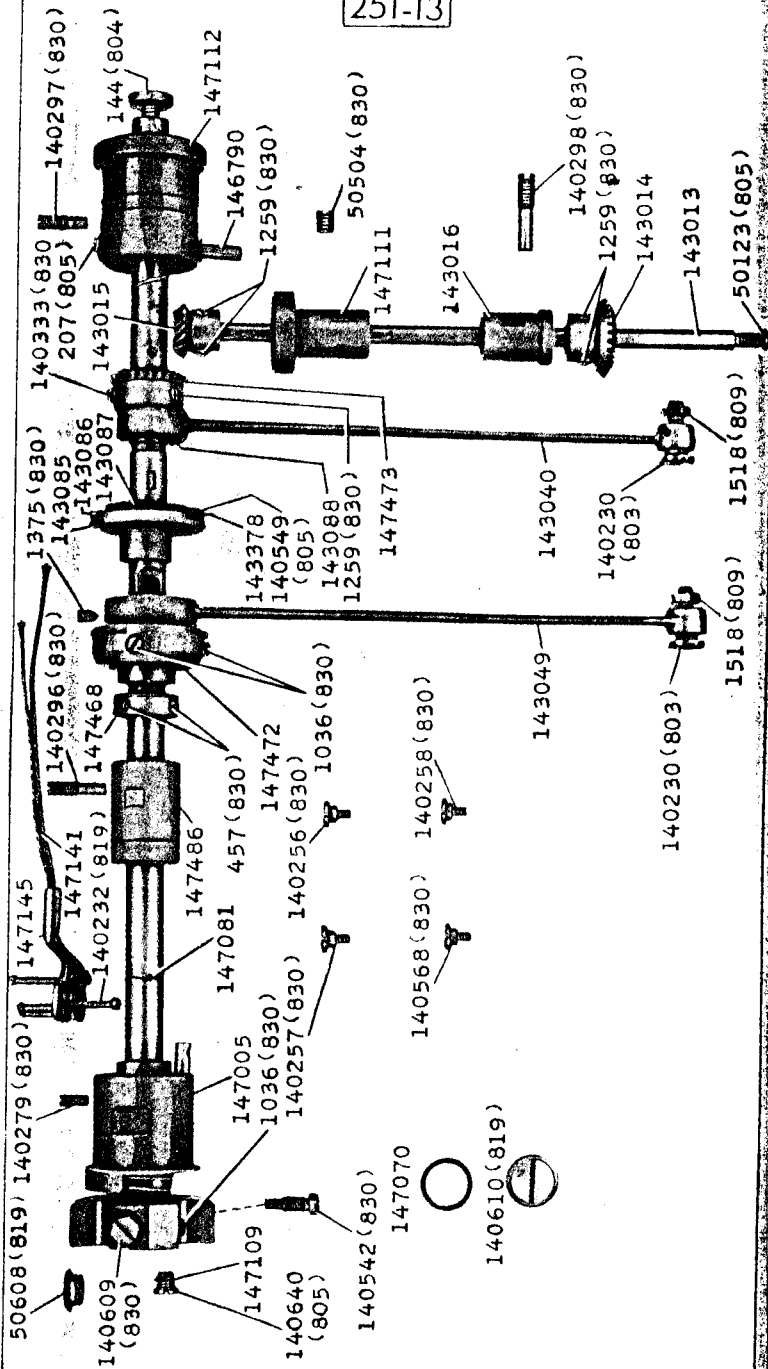

8272-1/2

251-11

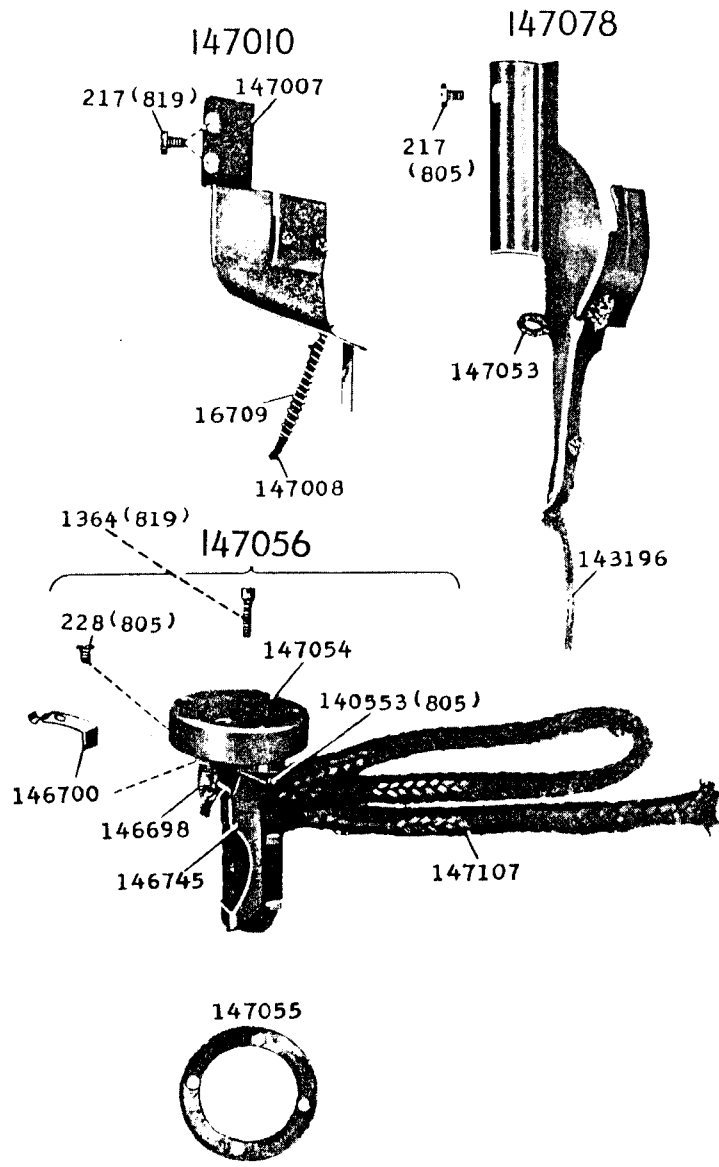

From the library of: Diamond Needle Corp.

8273-1/2

251-12 251-13

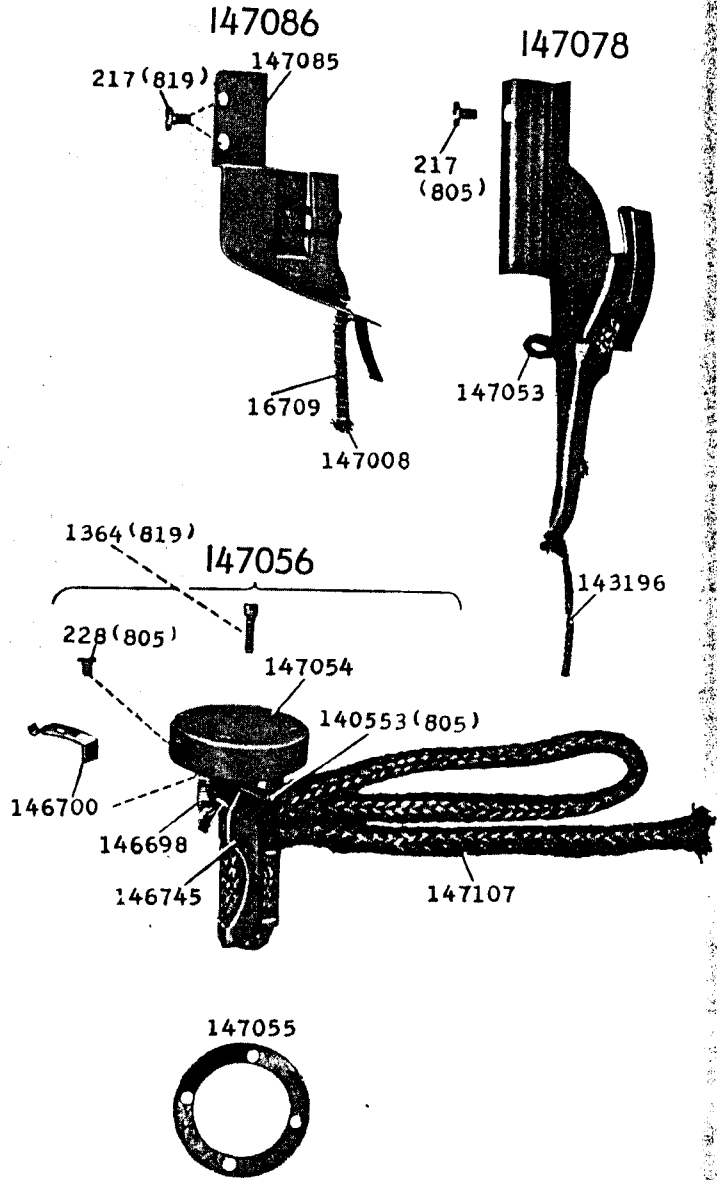

8274-2/3

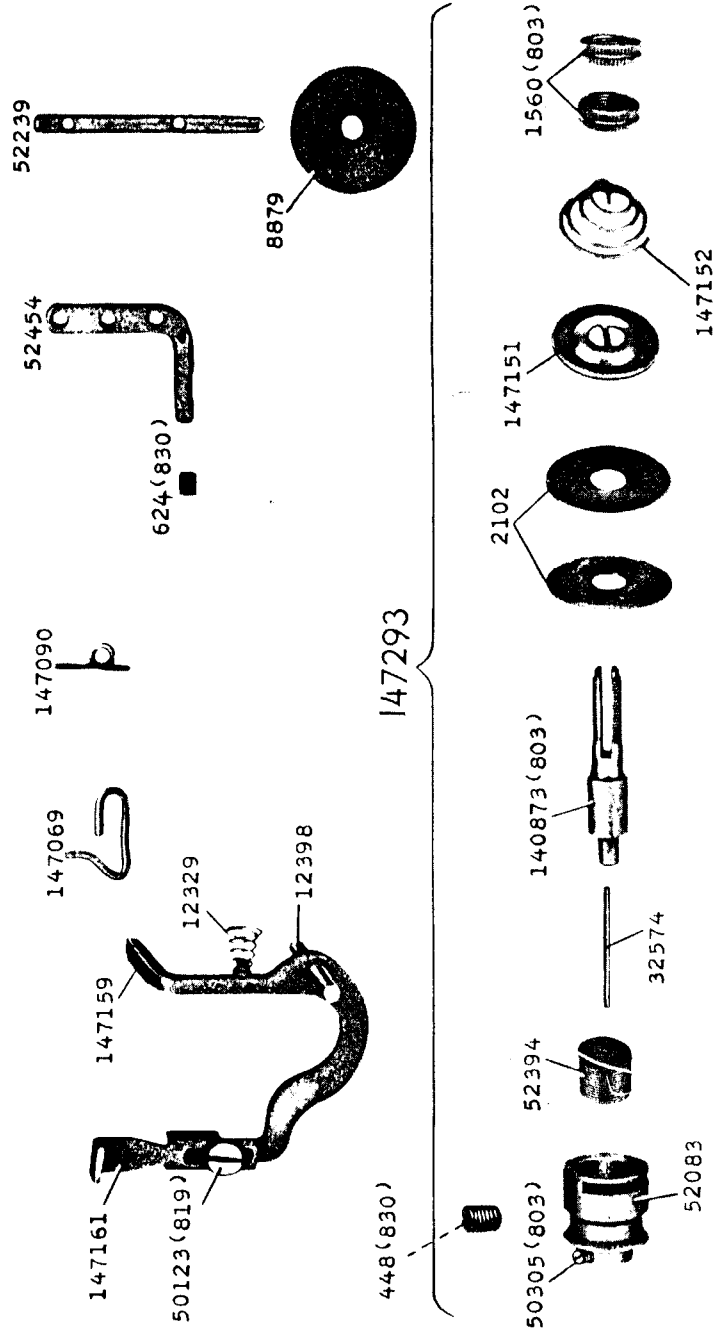

From the library of: Diamond Needle Corp

8275-2/3

8276-2/3

251-II

147015

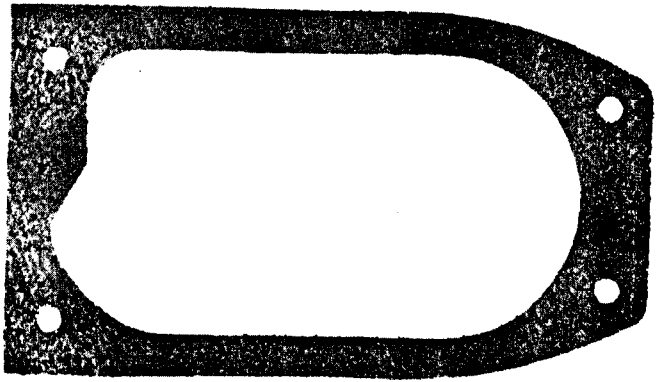

60117  
(830)

147315

22=1

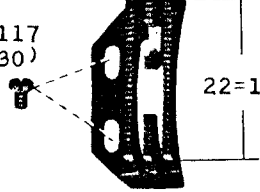

147320 (850)

691  
(850)

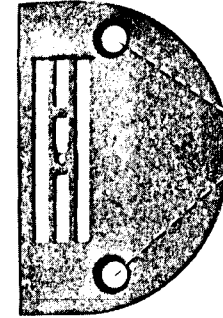

51369 (813)



147013

147011

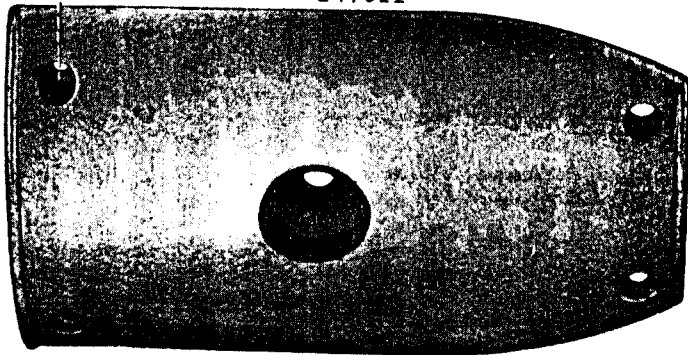

147308

140390 (830)



26231

147307

62527

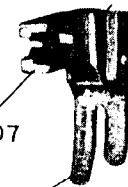

147306

12432

12431 (819)

4307

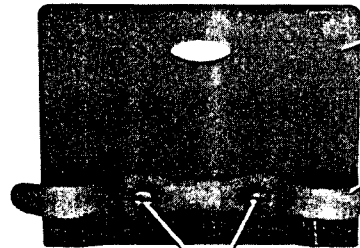

725 (819)

146511



64519



147105

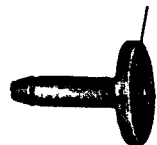

8277-2/3

251-12

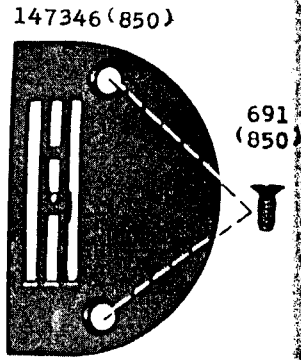
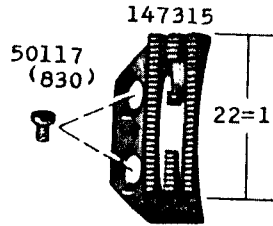

147308

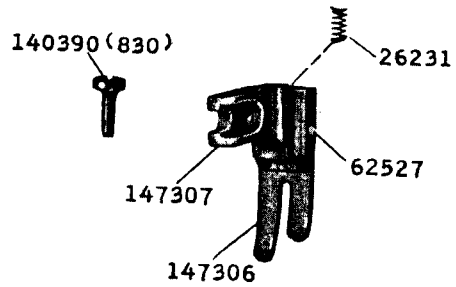

12432

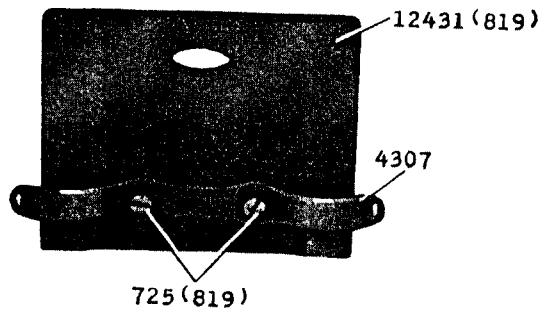

8278-2/3

251-13

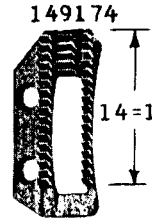
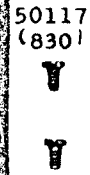

143175 (850)

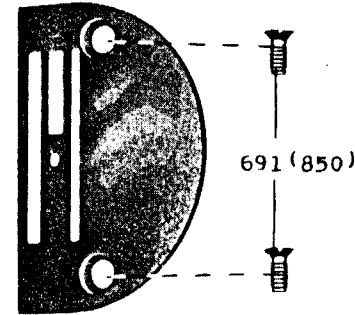

127234

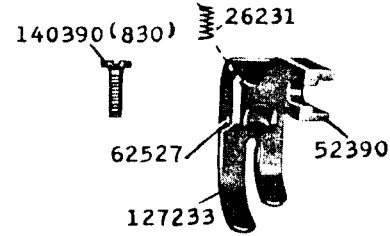

12432

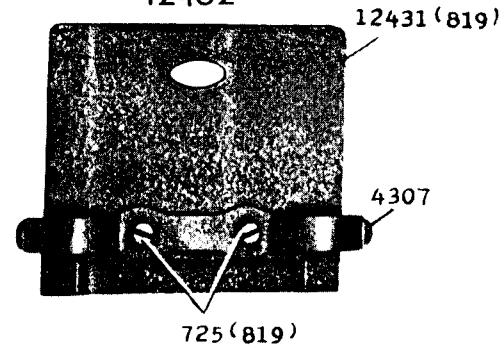



8279-1/2

8280-1/2

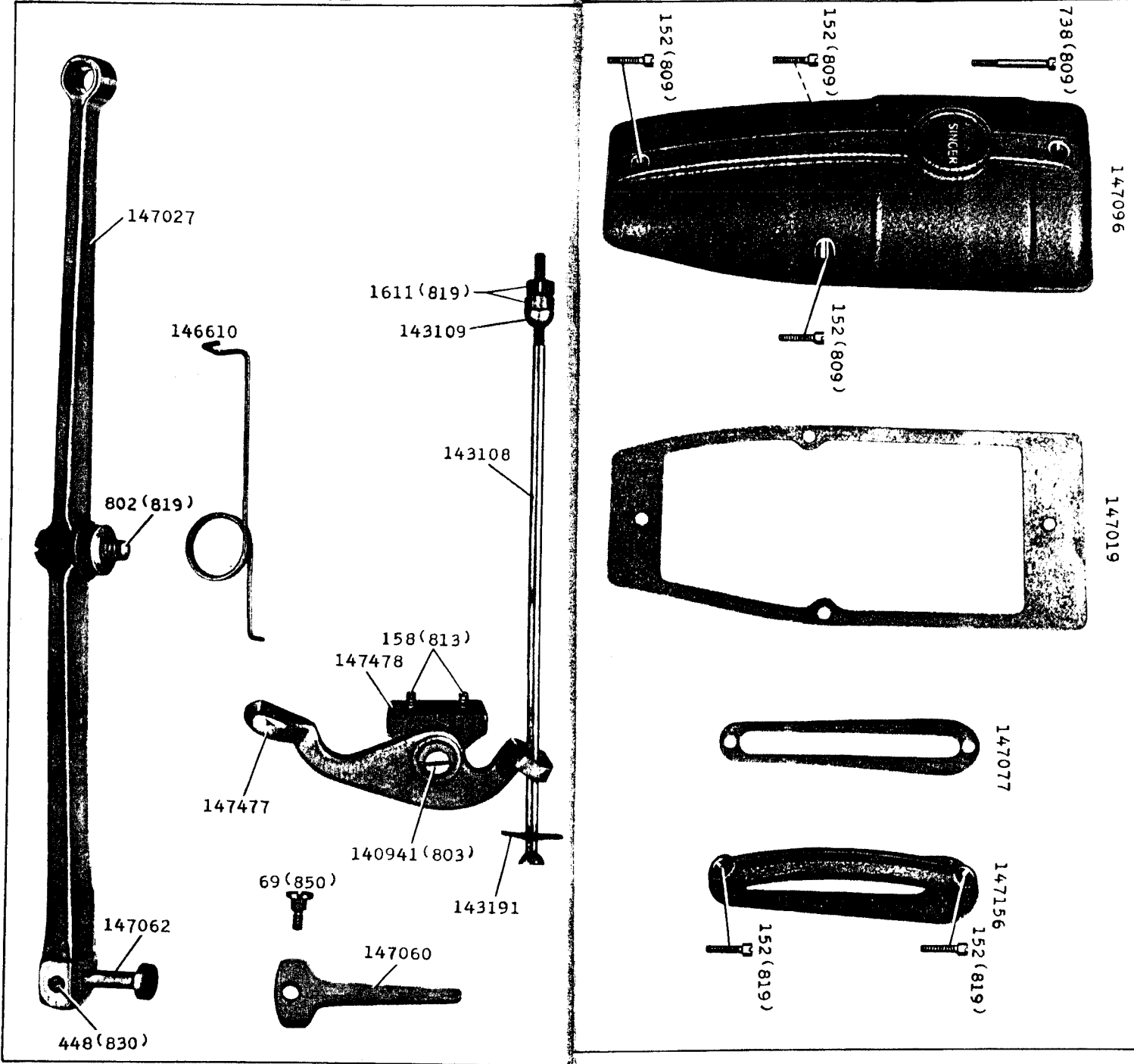

From the library of: Diamond Needle Corp.

8281-1/3

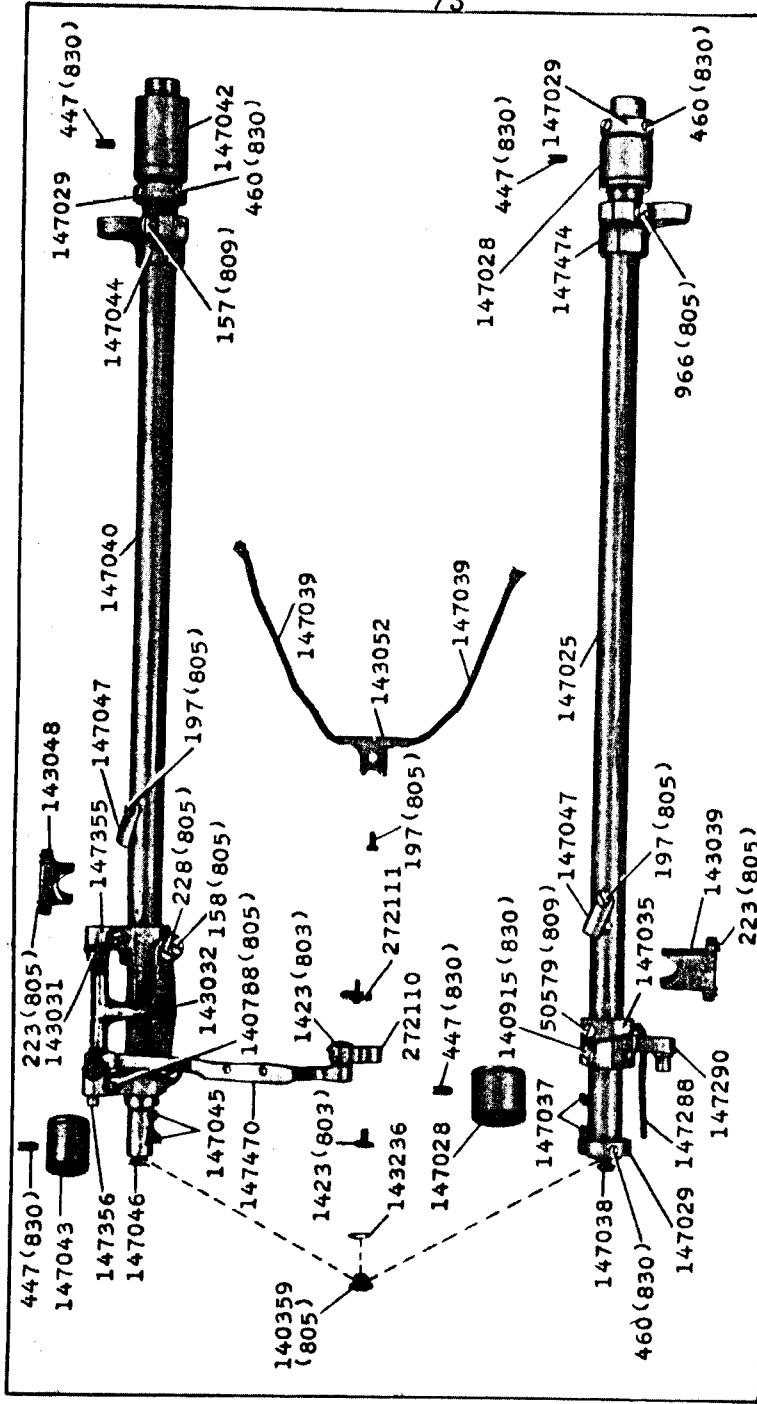

8282-2/3

251-II

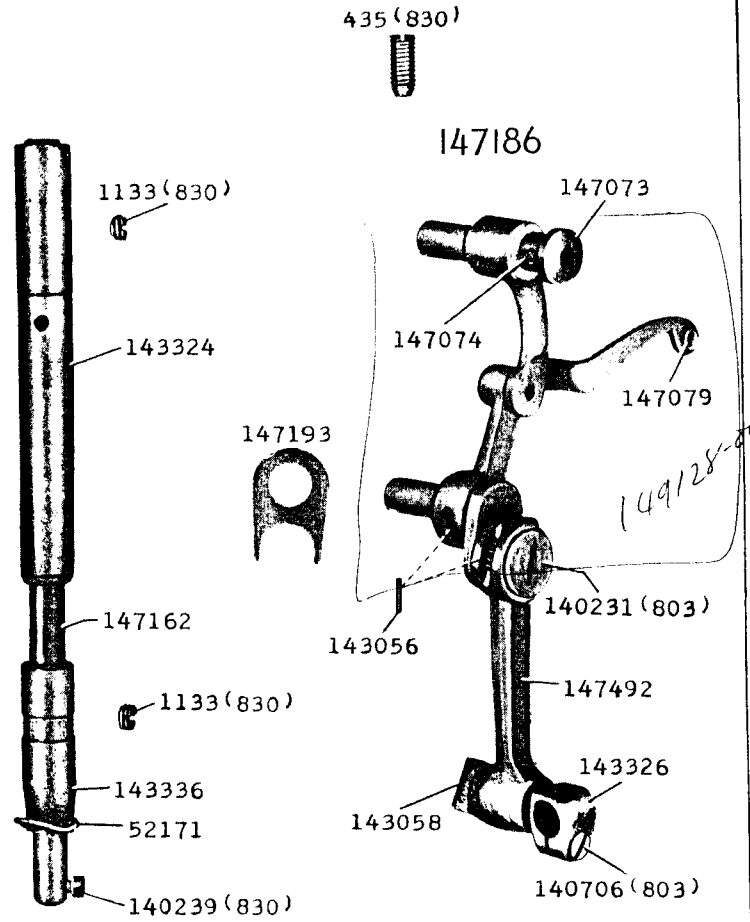

From the library of: Diamond Needle Corp.

8283-2/3

251-12

435 (830)



147186

1133 (830)

147073

147074

147079

143324

147193



147163

147113

1133 (830)

143056

140231 (803)

147492

147114

665 (809)

140119 (830)

143058

143326

143327

143328

140706 (803)

8284-2/3

251-13

435 (830)



147187

1133 (830)

147073

147074

147079

143324

147193



147163

147113

1133 (830)

143056

140231 (803)

147492

147114

665 (809)

140119 (830)

143058

143326

143327

143328

140706 (803)

From the library of: Diamond Needle Corp

8285-2/3

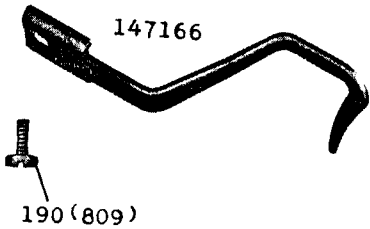
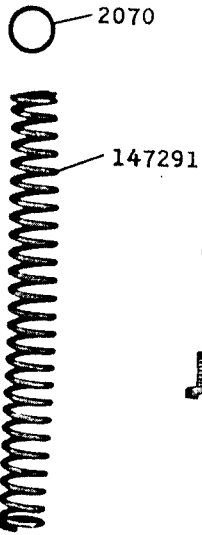
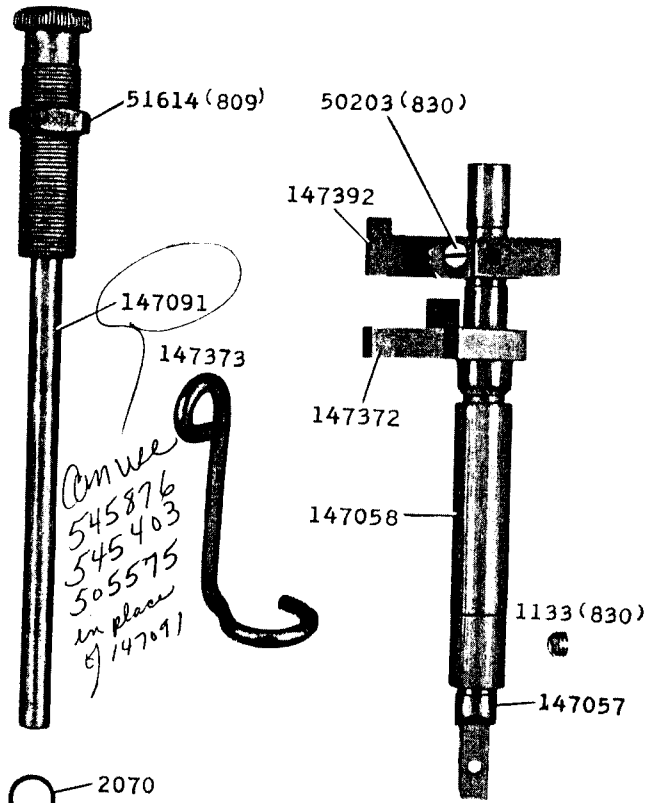

*Am use  
545876  
545403  
505575  
in place  
of 147091*

8286-1/2

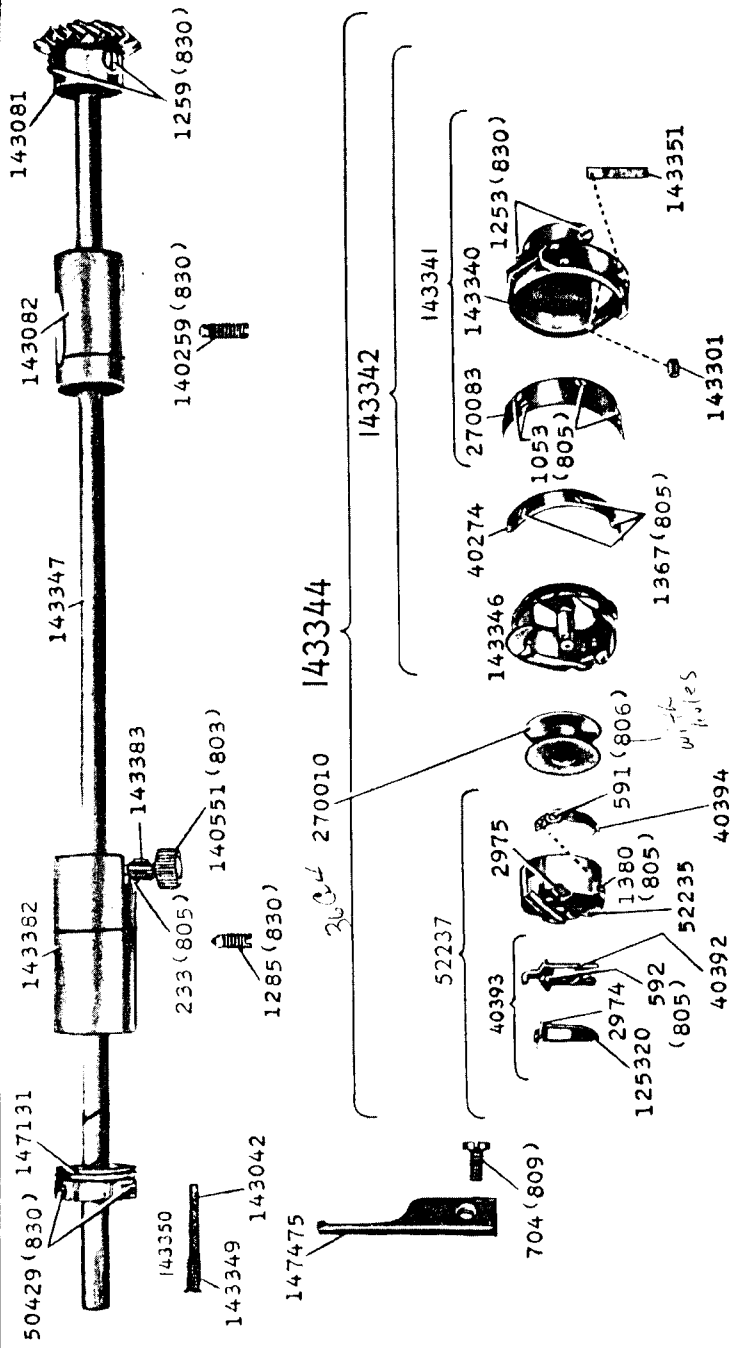

From the library of: Diamond Needle Corp.

8287-2/3

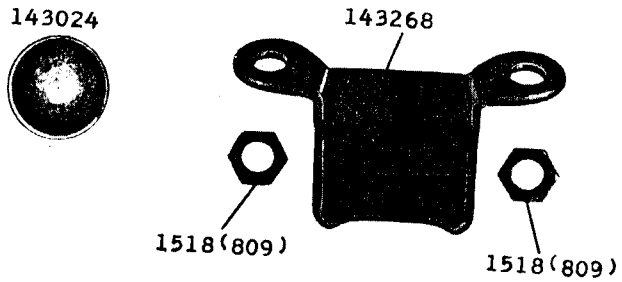
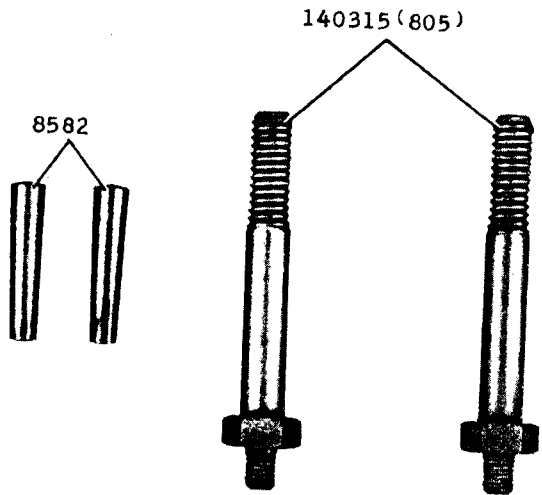
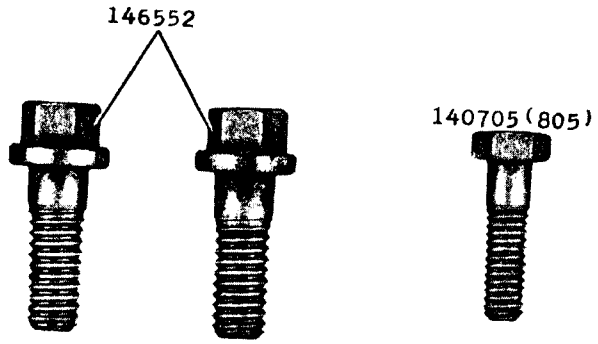

8288-2/3

251-II

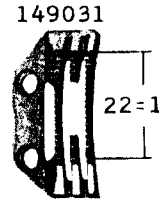

147336 (850)

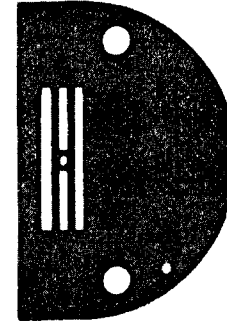

143219

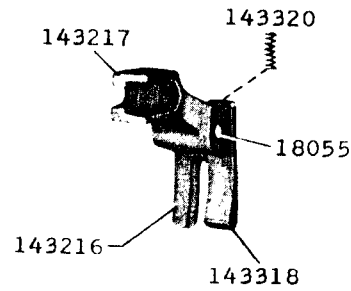

147338

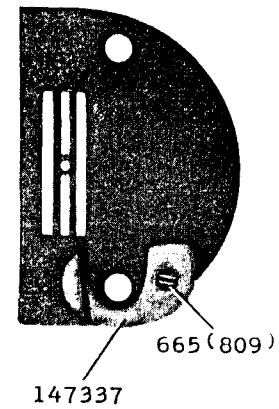

8289-2/3

251-II

147305

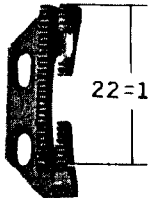

22=1

147309 (850)

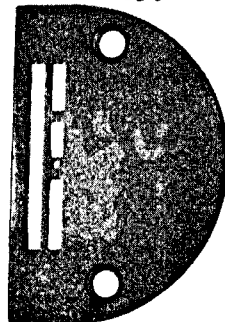

147326

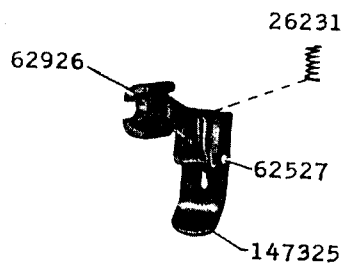

26231

62926

62527

147325

147305

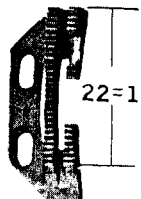

22=1

147309 (850)

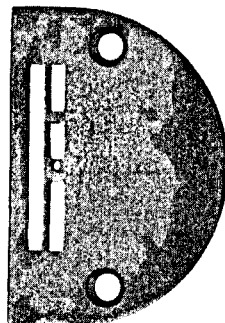

147308

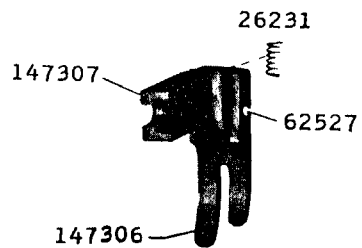

26231

147307

62527

147306

8290-2/3

251-II

147327

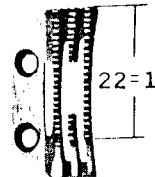

22=1

147328 (850)

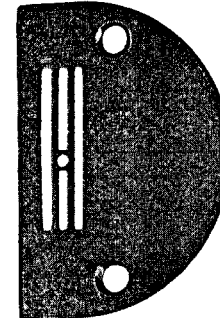

160674

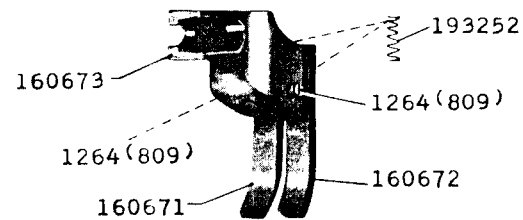

193252

160673

1264 (809)

1264 (809)

160672

160671

160677

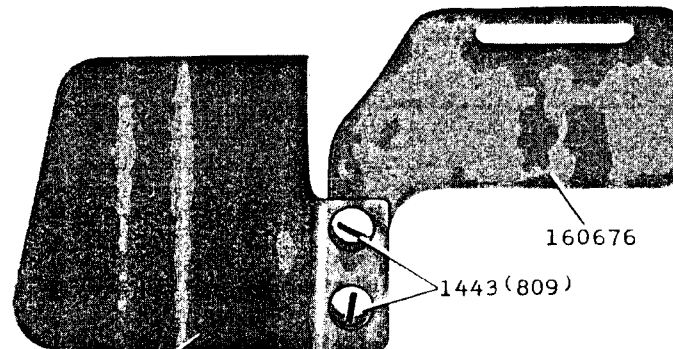

160676

160675

1443 (809)

8291-2/3

251-II

147305

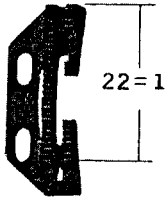

22=1

147309 (850)

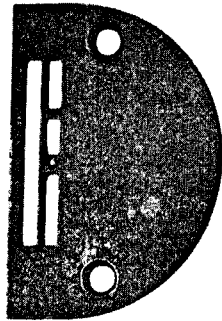

147331

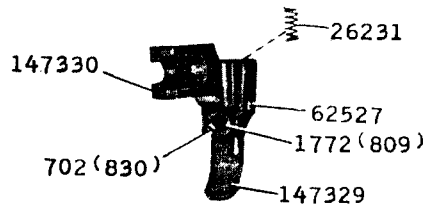

147330

26231

62527

1772 (809)

702 (830)

147329

147321

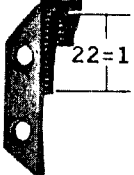

22=1

147324 (850)

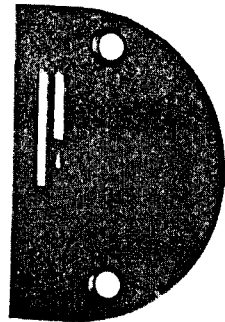

147323

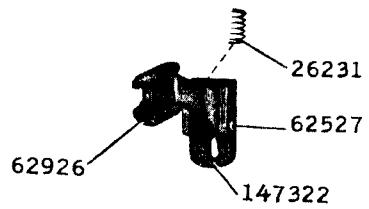

26231

62527

147322

62926

8292-2/3

251-II

147315

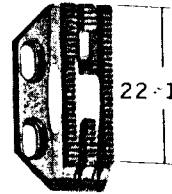

22=1

147320 (850)

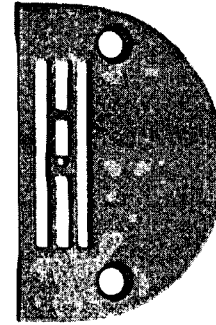

147319

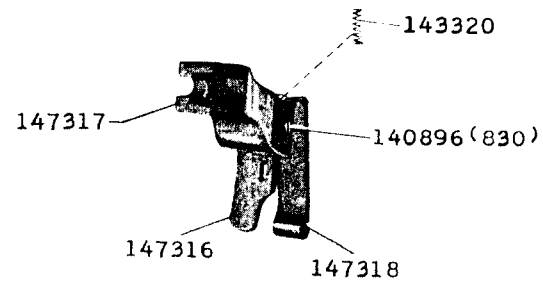

147317

143320

140896 (830)

147316

147318

8293-2/3

251-II

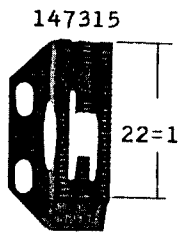

147320 (850)

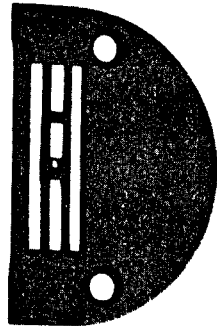

147335

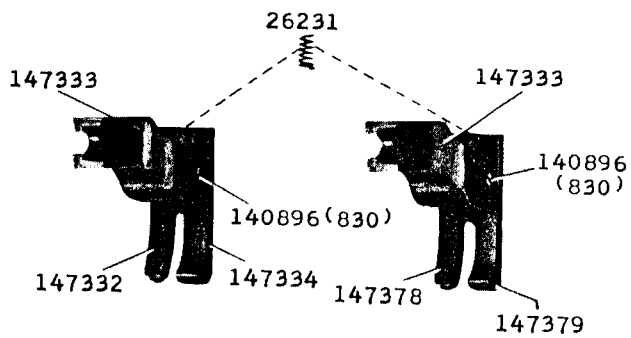

147380

147383

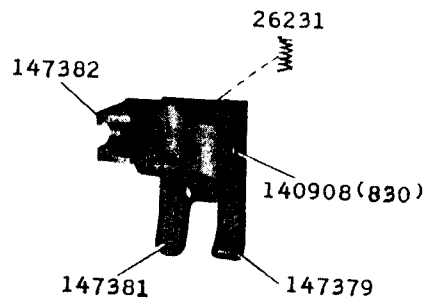

8294-2/3

251-II

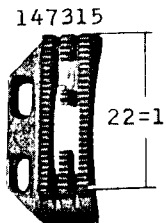

147320 (850)

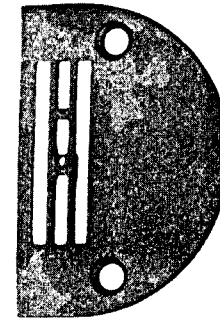

147371

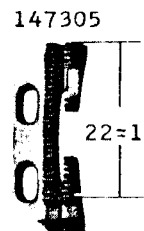
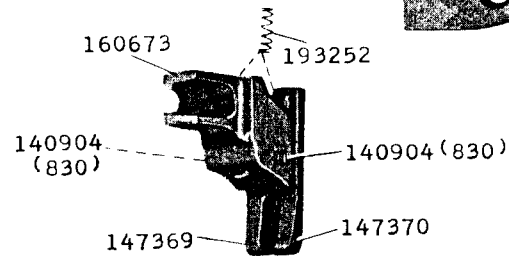

147309 (850)

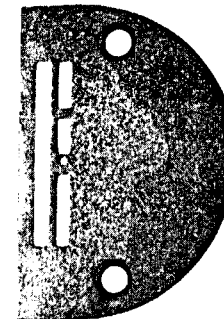

147312

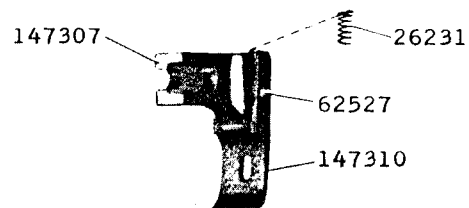



8295-2/3

251-II

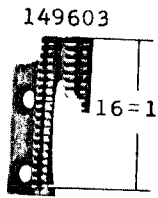

26606

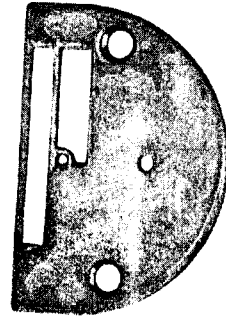

8296-2/3

251-II

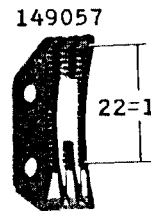

142060 (850)

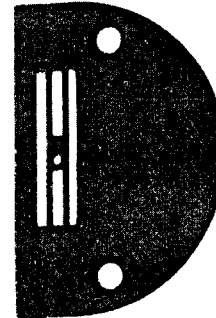

147340

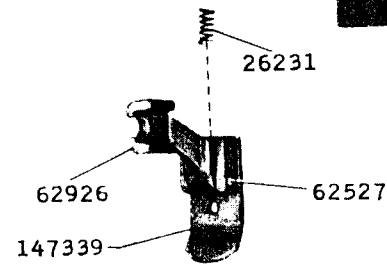

142060 (850)

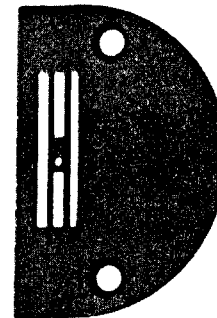

143219

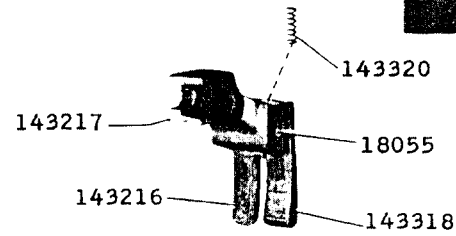

From the library of: Diamond Needle Corp

8297-2/3

25I-II

149137

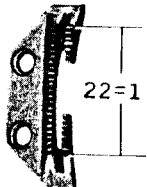

22=1

147314

26231

143278 (850)

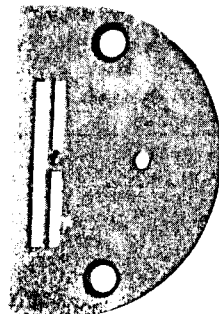

62926



62527

147313

147315

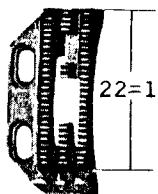

22=1

147349

26231

147320 (850)

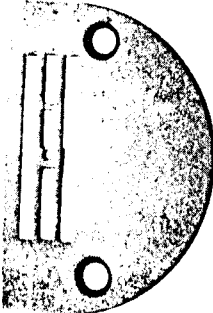

147348

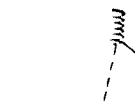

26276

702 (830)

1772 (809)

147347

8298-2/3

25I-I2

147305

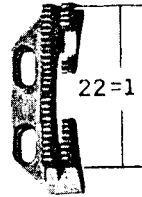

22=1

147308

147374 (850)

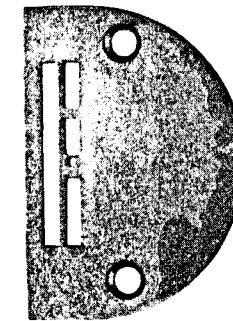

26231

147307



62527

147306

147315

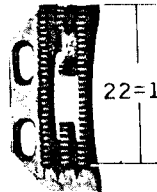

22=1

147308

147388 (850)

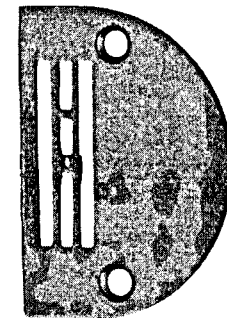

26231

147307



62527

147306

From the library of Diamond Needle Corp

8299-2/3

251-12

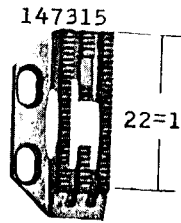

147346 (850)

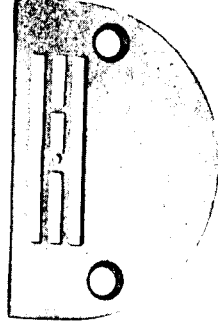

147335

147380

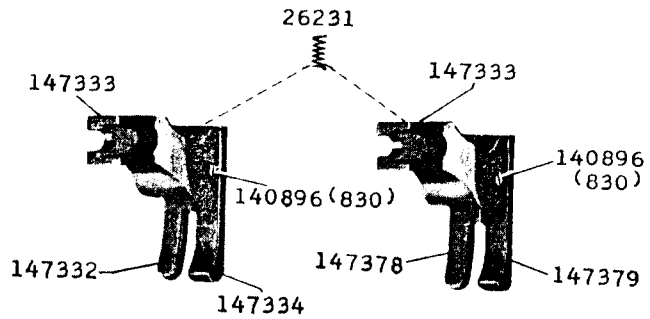

147383

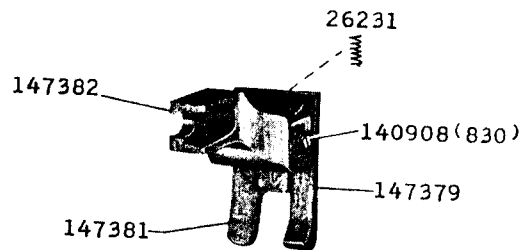

21251-2/3

251-12

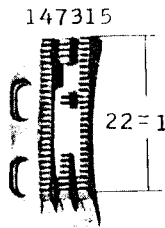

147346 (850)

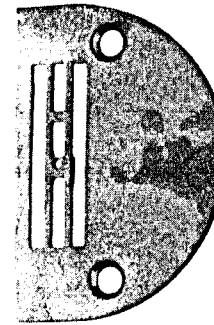

147371

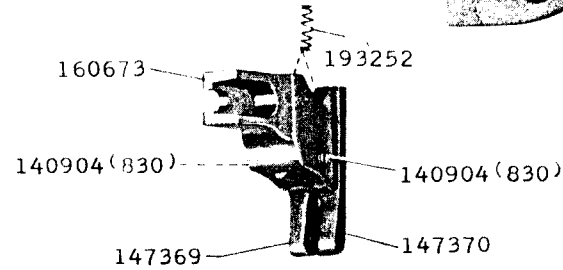

147346 (850)

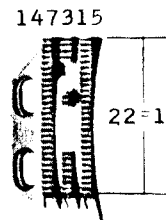

147349

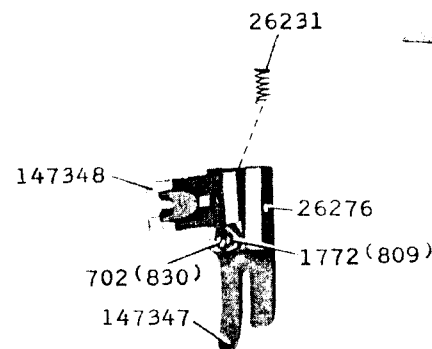

151434  
259074

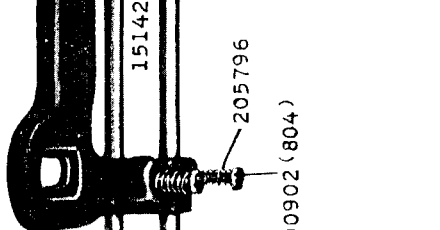
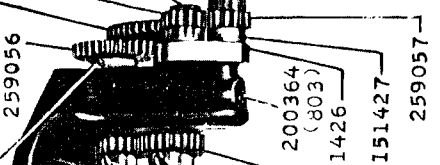
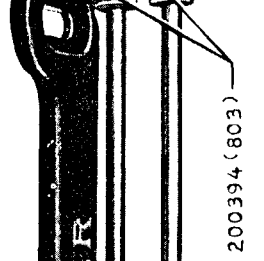
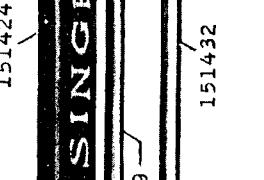
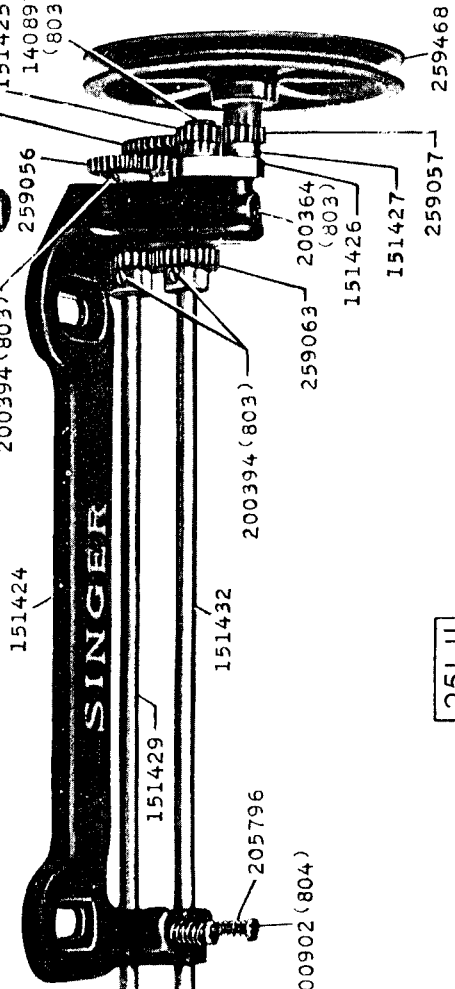
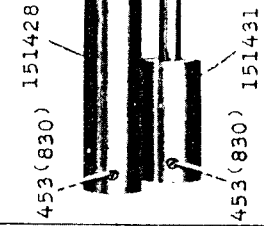
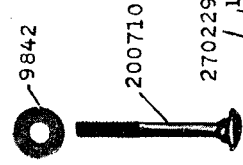
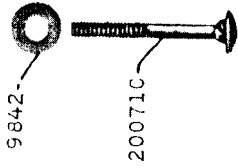

21252-1/2

251-III

21253-1/2

251-II

647(819)

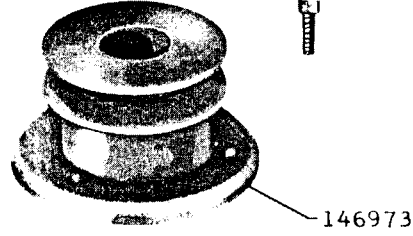
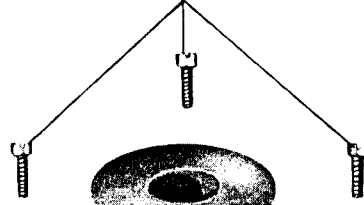

147343

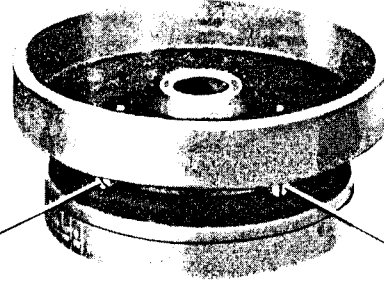

51283(830)

51283(830)

150733

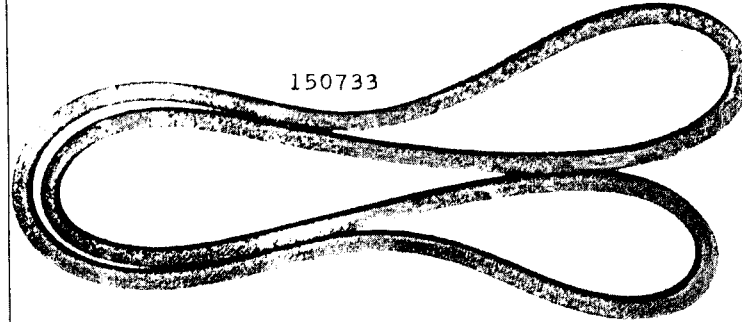

From the library of: Diamond Needle Corp

21254-1/2

147484

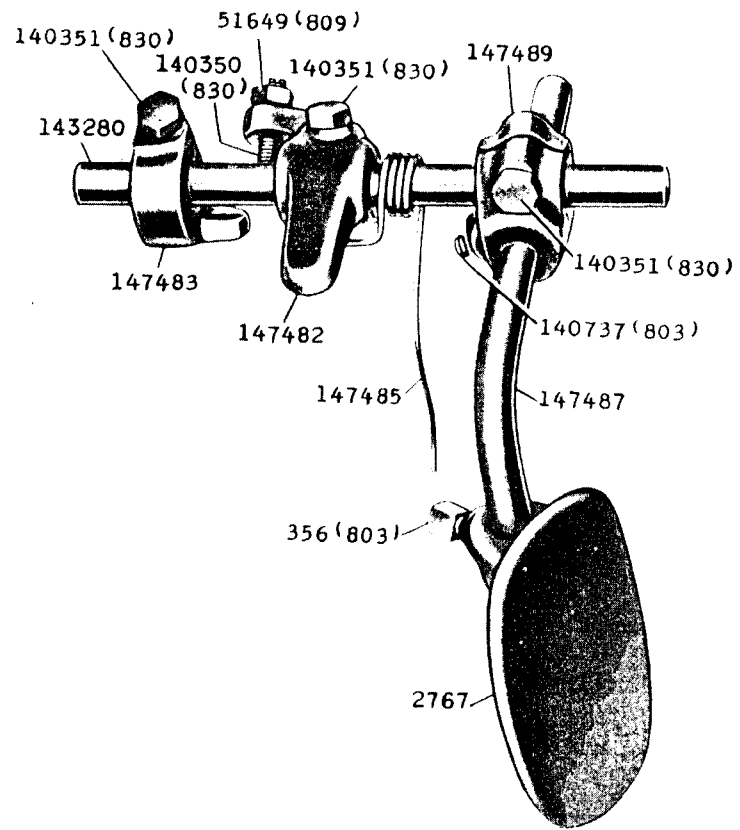

21255-1/3

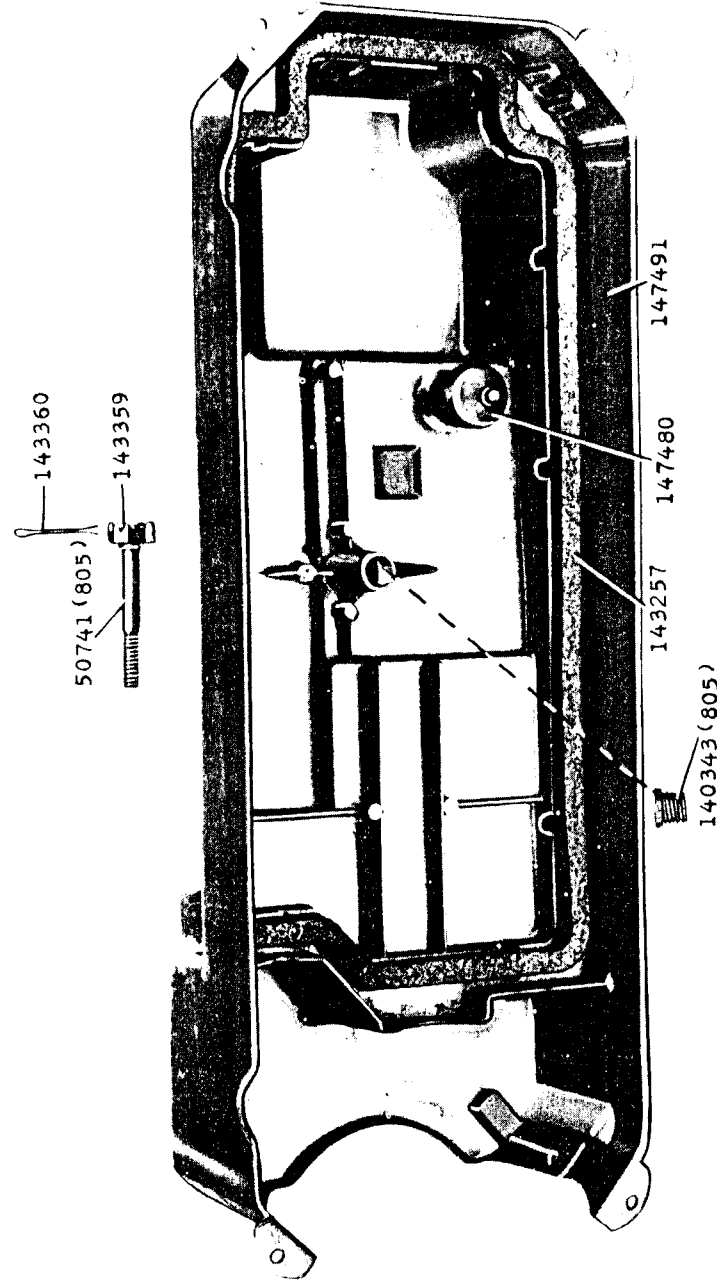

From the library of: Diamond Needle Corp

23253 - 3/8

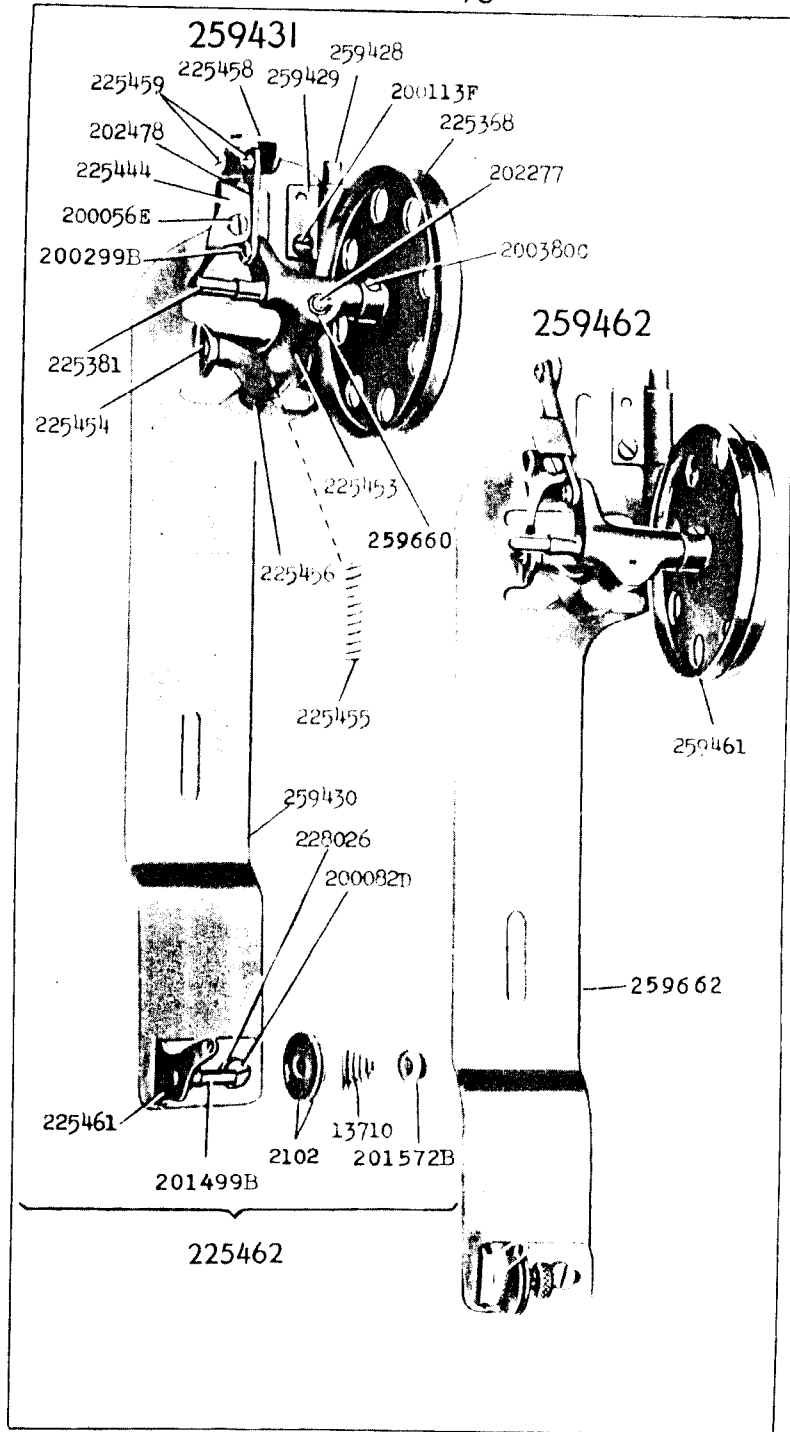

24193 1/6

228776

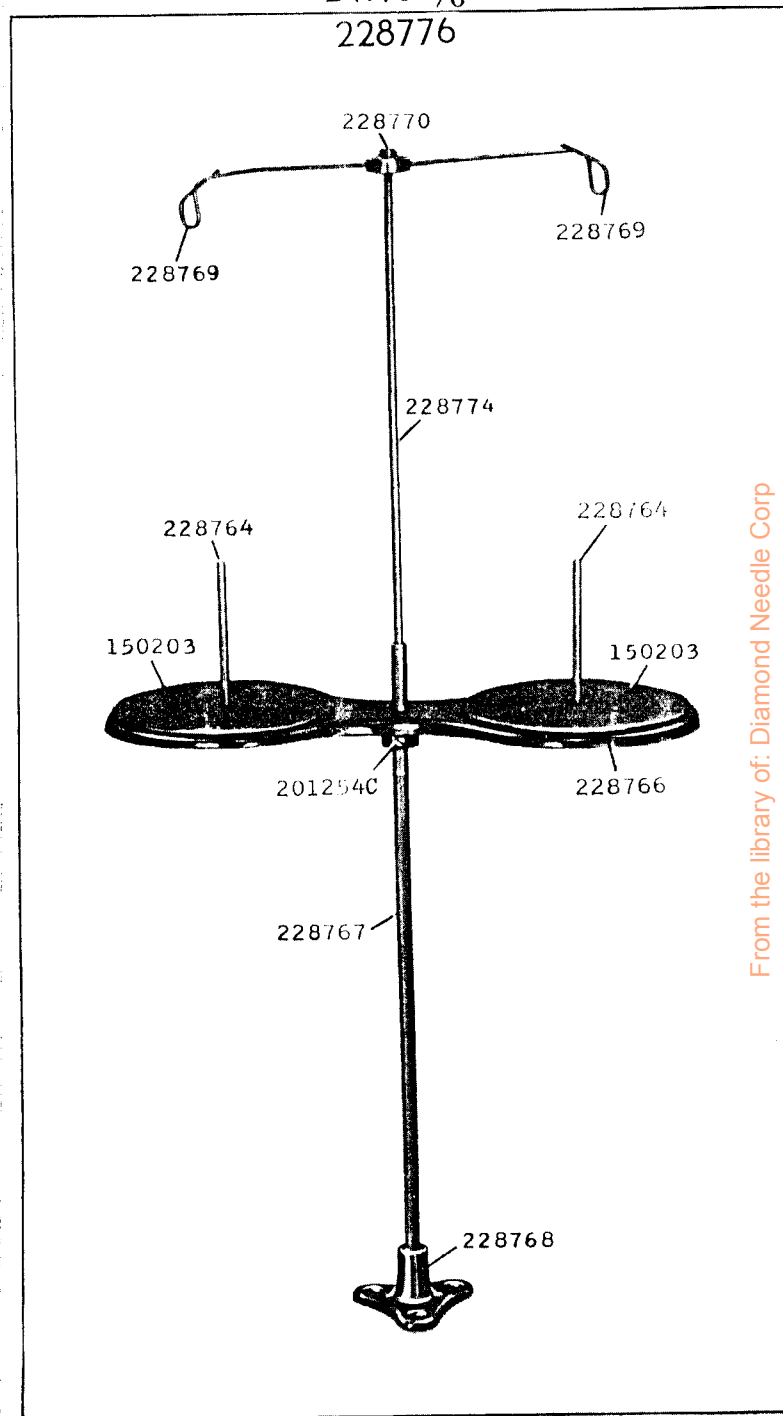

From the library of: Diamond Needle Corp